

BALANCE SYSTEM™ SD (version 4.x)

INSTRUCTIONS FOR USE

950-440	System, Balance SD, 115 VAC 15.6" display
950-441	System, Balance SD, 230 VAC 15.6" display
950-444	System, Balance SD, 100 VAC 15.6" display
950-450	Optional FreeSway Handles



BIODEX

Biodes Medical Systems, Inc.

20 Ramsey Road, Shirley, New York, 11967-4704, Tel: 800-224-6339 (Int'l 631-924-9000), Fax: 631-924-9241, Email: info@biodes.com, www.biodes.com

BALANCE SYSTEM™ SD (version 4.x)

This instructions for use document covers safe operation of the Balance System SD.

Additional information and resources are available upon request or directly from the Biodex website: www.biodex.com/balance.

Here, the user can find information from compliance to clinical support, and if the desired information is not found, Biodex can be contacted directly at supportservices@biodex.com.

Thank you,

Biodex Medical Systems, Inc.

Contact information



Manufactured by:

Biodex Medical Systems, Inc.
20 Ramsey Road, Shirley, New York, 11967-4704
Tel: 800-224-6339 (Int'l 631-924-9000)
Fax: 631-924-8355
email: supportservices@biodex.com
www.biodex.com



















Table of Contents

Definition of Symbols	5
Product Certifications and Classifications	6
Warnings and Cautions.....	8
Important Safety Information	8
1. Introduction	10
Intended Use	10
Indications for Use	10
Contraindications for Use	10
2. Installation and Configuration.....	12
Positioning the Balance System SD and Printer Stand	12
Leveling the Base	12
Installing the Printer.....	13
Installing Optional Accessories	13
Assembling the Printer Stand with Optional FreeSway Hooks	14
Turning On the System	15
Turning Off the System.....	16
Configuring the System	17
Common Icons and Buttons.....	20
3. Planning a Session.....	21
Evaluating a Patient	21
Setting Up a Session.....	21
4. Getting Started.....	23
Starting a Session	23
Adjusting the Support Handles	23
FreeSway Handles	24
Adjusting the Display	25
Positioning the Patient’s Feet	26
Common Actions	26
Setting Up a Training Session.....	27
Setting Up a Test Session.....	27
Saving Results and Creating Reports	28
5. Training Modes	29
Percent Weight Bearing Training	29
Weight Shift Training.....	30
Postural Stability Training.....	31

	Motor Control Training	32
	Maze Control Training	33
	Random Control Training	34
6.	Testing Modes	35
	Sensory Integration Tests	36
	Clinical Test of Sensory Integration of Balance (CTSIB)	36
	Balance Error Scoring System (BESS)	38
	Limits of Stability (LOS) Test	39
	Postural Stability Test	40
	Motor Control Test	41
	Bilateral Comparison Test	42
	Fall Risk Test	43
7.	Utilities	44
	Reports	45
	Configuration	49
	Change Sensory Integration Defaults	49
	Changing Fall Risk Defaults	51
	Managing Custom Protocols	51
	Creating a New Protocol	51
	Managing Custom Sensory Tests	53
	Patient Management	55
8.	VibroTactile™ System	60
	Getting Started	61
	Attach the Link Box	61
	Connect to the Display	62
	Charging the tactile belt receivers	64
	Configuring Equipment in Facilities with One VibroTactile System	68
	Configuring Equipment in Facilities with Multiple VibroTactile Systems	70
9.	Maintenance	71
	System Maintenance	71
	Updating System Software	72
	Cleaning the Balance System	72
	Maintaining the Printer	73
	Disposal	73
10.	Specifications and Certifications	74

Definition of Symbols

The following symbols and their associated definitions are used and implied throughout this manual.

Symbol	Definition
	Carefully read these instructions prior to use
	Operating Instructions
	Caution
	General Warning
	General Mandatory Action
	Dangerous Voltage
	“On” Power
	“Off” Power
	Pinch Point
	Earth (ground)
	Alternating Current
	Fuse
	USB Connector/Cable
	Non-Ionizing Electromagnetic Radiation
	Waste in Electrical Equipment
	Disposal Classification and Identification of Equipment
	Date of Manufacture
	Manufactured By
	Type B Applied Part

Product Certifications and Classifications

This product has received the following certifications and falls within the following classifications:

- SGS Listed Electrical Equipment
- ANSI/AAMI ES60601-1:2005+A1:2012+C1:2009+A2:2010
- CAN/CSA C22.2 No: 60601-1:14
- CE Marked, Class IM
- FDA Class I
- EC Certificate: EC #41312068-01
- Electromagnetic Compatibility: This equipment complies with the Medical Equipment IEC 60601-1-2:2014 EMC Standard.
- Type B Applied Part 



Mi-Wi Communication Software - Copyright JD Birck, LLC

United States:

Contains FCC ID: OA3MRF24J40MA

Canada:

Contains IC: 7693A-24J40MA

This equipment has been tested and found to comply with the limits for a Class B digital device, pursuant to part 15 of the FCC Rules. These limits are designed to provide reasonable protection against harmful interference in a residential installation. This equipment generates, uses, and can radiate radio frequency energy, and if not installed and used in accordance with the instructions, may cause harmful interference to radio communications. However, there is no guarantee that interference will not occur in a particular installation. If this equipment does cause harmful interference to radio or television reception, which can be determined by turning the equipment off and on, the user is encouraged to try to correct the interference by one or more of the following measures:

-
- Reorient or relocate the receiving antenna.
 - Increase the separation between the equipment and receiver.
 - Connect the equipment into an outlet on a circuit different from that to which the receiver is connected.
 - Consult the dealer or an experienced radio/TV technician for help.

NOTE: *Circuit diagrams, component part lists, descriptions, calibration instructions, or other information used to assist service personnel to repair those parts of the equipment that are designated as repairable for this product are provided on the Biodex website, www.biodex.com or can be obtained by contacting Biodex Customer Service (see Contact information).*

Note: *Complete information on the Electromagnetic Compatibility for the Biodex Balance System can be located in the Compliance Supplement located on the Biodex website (www.biodex.com) or can be obtained by contacting Biodex Customer Service (see Contact information).*

Note: *Normative Data for the Balance System is located in the Normative Data Supplement located on the Biodex website (www.biodex.com) or can be obtained by contacting Customer Service.*

Authorized European Community Representative:



Emergo Europe
Prinsessegracht 20
2514 AP, The Hague
The Netherlands

Warnings and Cautions



NOTE: The warnings, cautions, and instructions provided in this manual must be read, followed, and always kept available for consultation.



CAUTION: Do not modify this equipment without authorization from the manufacturer. Unauthorized modifications to this system are not permitted and void the manufacturer's warranty. Unauthorized modification might result in a hazard to the user and/or patient.



CAUTION: Federal Law restricts this device to sale by or on the order of a medical practitioner. When prescribed for therapeutic purpose, a physician must define the use clearly (for example, total work, maximum heart rate, and so on) to reduce the risk of patient injury.

Important Safety Information



Read the entire operation manual. Failure to read the manual might result in user error or inaccurate data. Save all documents for reference.



WARNING

- Allow only qualified, trained personnel to operate or service this system.
- Do not use this system in a manner other than specified in this manual. If the equipment is used in a non-specified manner, the protection provided by the equipment might be impaired and results could be compromised.



WARNING: Never leave patient unattended.



This medical electrical equipment requires special precautions for EMC and must be installed and used according to EMC information located on the Biodex website (www.biodex.com).



WARNING: Only use approved power supplies.



CAUTION: Operation for: 115–230 VAC, 50/60 Hz.



CAUTION: To avoid risk of electric shock, this equipment must be connected only to supply mains with protective earth.



CAUTION: The plug is considered the method of disconnecting the system from main power. Do not place the system in a position where the plug cannot be reached quickly.



CAUTION: The system is intended to remain in one location during operation. To relocate the system, the system is disconnected from power source. One person can move the system. Use the wheels to move the system.



WARNING: Connecting electrical equipment to a multiple socket outlet (MSO) effectively leads to creating an ME SYSTEM, and can result in a reduced level of safety.

Patient Weight: 60 lb (27 kg) – 400 lb (181 kg)

Operating Conditions

- Temperature: 15° C to 30° C (60° F to 86° F).
- Humidity Range: 30% to 75% (non-condensing).
- Atmospheric Pressure: 70kpa (10psi) to 106kpa (15psi).

Storage Conditions

- Temperature: -20° C to 60° C (-4° F to 140° F).
- Humidity Range: 10% to 100%.
- Atmospheric Pressure: 50kpa to 101kpa (7psi to 15psi)

Water Resistance Rating: IPX0

1. Introduction

Intended Use

The Balance System SD is an assessment tool which allows for testing and training in both static and dynamic formats. It is a versatile product, providing capabilities for balance assessment, concussion management, measurement of kinesthetic and proprioceptive abilities, and determining neuromuscular control (stability and degree of sway values).

Indications for Use

The Balance System SD is indicated to be used for various populations such as neurological disorders, orthopedic, deconditioned, fall risk, concussion management and other general conditions.

Contraindications for Use

Contraindications include severe osteoporosis, non-union fractures, Bariatric patients weighing greater than 400 pounds, patients under 60 pounds, patients with poor safety awareness/cognition, acute conditions such as pulmonary embolus, thrombus, acute MI, acute fractures, BP over 180/110 Hg, patients with severe debilitating dizziness.

Parts and Accessories



Figure 1.1. Balance System SD with Printer and Stand:

List of Parts

- Power Cable
- Power Adapter
- Printer Power Cable
- USB Cable
- CTSIB Indexed Pad
- Printer
- Printer Stand
- Wrench

Optional Parts

- FreeSway Handles
- USB keyboard or mouse
- External VGA monitor
- VibroTactile™ System

The optional VibroTactile™ System offers an additional form of sensory feedback. Using wireless technology, the belt responds with a vibrating sensation when the patient sways outside the target area. The vibrating feedback is helpful when training requires the patient's eyes to be closed.



Figure 1.2. VibroTactile System.

The CTSIB Indexed Pad is a foam pad that is placed over the platform for sensory integration testing.



Figure 1.3 CTSIB Indexed Pad.

The optional FreeSway Handles are free-floating, yet contained within a controlled opening. They allow patients to experience unimpeded postural sway while holding onto handles that are available for support. The FreeSway Handles are ideal for regaining balance and stability.



Figure 1.4 FreeSway Handles.

2. Installation and Configuration

The Balance System SD is shipped in a single carton. The System is assembled before shipment and is ready to operate. The printer requires installation.

Positioning the Balance System SD and Printer Stand

1. Determine the location for equipment.



CAUTION: The plug is the method of disconnecting the system from the main power. Do not place the system in a position where the plug is not immediately accessible.



This medical electrical equipment requires special precautions regarding EMC and must be installed and used according to EMC information.

2. To move the Balance System SD, tip the system and use the wheels to roll the system into position. When the system is upright, the wheels are not in contact with the floor and the system is in a fixed position.
3. Position the printer stand next to the Balance System SD.
4. Set the printer on its stand.

Leveling the Base



Figure 1.5 Leveling the Base.

1. Loosen the jam nut using the wrench provided. The wrench is magnetic and can be stored on the Balance System.
2. Adjust the leveling guide with the wrench until the base is level and stable.
3. Tighten the jam nut so it is flush against the base again.

Installing the Printer



Read the printer manual. Locate the USB port and the power inlet.

1. The Balance System SD ships with the USB cable inserted into the display. Insert the other end of the cable into the USB port of the printer.
2. Insert the printer power cable into the printer power inlet.
3. Insert the printer AC plug into the power adapter.
4. Install the power adapter AC plug into the Balance System SD.



WARNING: Do not connect any other equipment to the Balance System SD power inlet.

5. Arrange the USB cord and the power cables so they do not interfere with the Balance System SD platform or support handles.
6. Refer to the printer manual for instructions for managing paper and ink cartridges.

Important Notice Concerning Supplied Printer Ink Cartridges

The printer ink cartridges for the Hewlett-Packard (HP) printer supplied with the Biodex product may not be compatible for customers outside of the North America, South America, Australia and some Pacific countries. Do not install the supplied printer cartridges before reading the enclosed information included with the printer.

Installing Optional Accessories

Locate the necessary cable and power cords for the optional external monitor, keyboard, or mouse.

1. Connect the monitor VGA cable to the port on the bottom of the system display.
2. Connect the monitor power cord to an AC power supply.
3. Connect the keyboard and mouse cables to the USB ports on the bottom of the system display.

Assembling the Printer Stand with Optional FreeSway Hooks

When the printer stand is not in use, it can be used to hang the Optional FreeSway Handles. Refer to the printer stand drawing.

1. Remove hooks and all hardware from packaging.
2. Apply Loctite to the nut.
3. Put the nut onto the hook.
4. Place the washer on top of the nut.
5. Insert hook into the bottom of the stand.
6. Insert finishing washer over the stud.
NOTE: *The flange should be sticking up.*
7. Apply Loctite to second nut.
8. Thread on the second nut and tighten.
NOTE: *Ensure the hooks are orientated correctly, pointing outwards as shown in the diagram before tightening.*
9. Apply plastic cap.
10. Repeat steps 1-9 for the remaining three hooks.

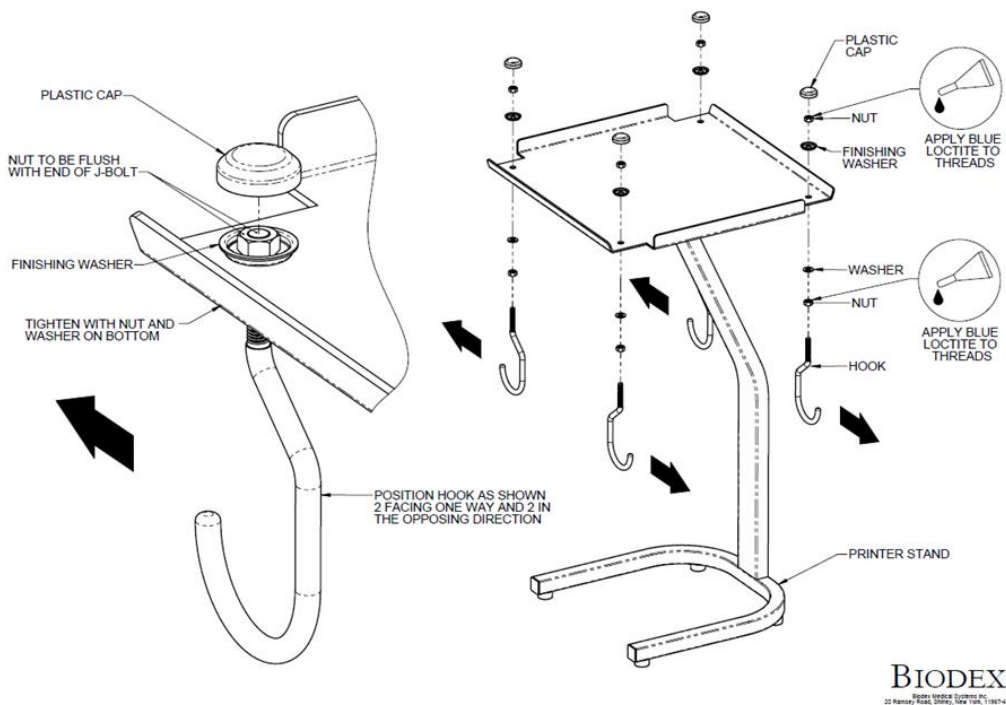

Figure 1.6 Printer Stand with Optional FreeSway Hooks.

Turning On the System

The Balance System SD turns on when the power cord is plugged into an AC power supply. The software starts automatically.

1. Plug the power cord of the Balance System SD into an AC power supply. The Home screen is displayed (see
- 2.
- 3.
4. Figure 2.1). The Balance System platform is active and in the locked position.



Figure 2.1. Home Screen .

5. Turn on the printer.
6. If an external monitor is used, turn on the monitor. At the Home screen, select <Utilities > <Configuration >, <System Configuration >, <Screen Configuration >, and <Mirror to External Monitor>.

Turning Off the System



CAUTION: Shut down the software before unplugging the device.

To preserve the Balance System SD database, use the proper sequence to turn off the system:

1. Shut down the software as illustrated in Figure 2.2.
2. Unplug the system from the power supply.

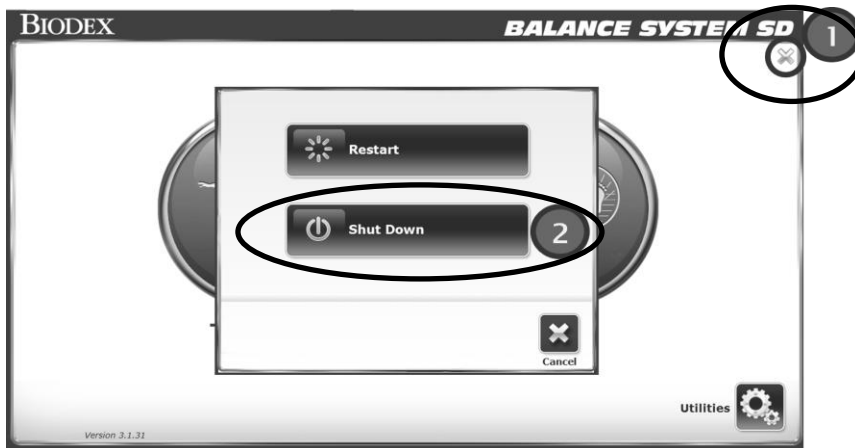

Figure 2.2. Shut Down Icon.

The software can be restarted while the system is plugged in. Touch the rocker switch on the bottom of the display to restart the software (see Figure 2.3).



Figure 2.3. Power Switch on Display.

Configuring the System

1. Touch <Utilities> on the Home screen.
2. At the Access ID Code screen, enter the ID code **159** and touch <OK>.
3. Touch <Configuration>.
4. Touch <System Configuration>
5. Select display options and set values for actions (see Figure 2.4).

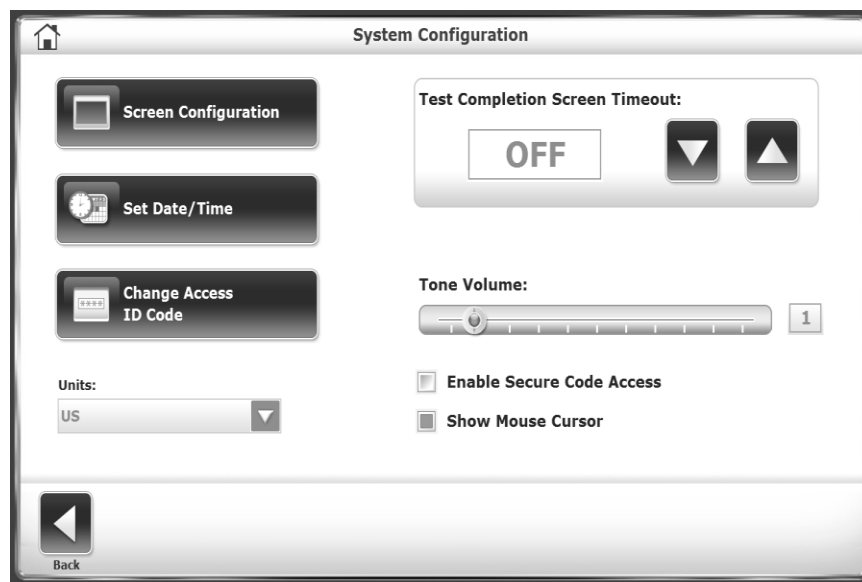

Figure 2.4. System Configuration Screen.

Table 2.1 System Configuration Functions.

Function	Default	Options
<Test Completion Screen Time Out> Set the number of minutes to display the test results after a test.	One minute	Touch the <▲> or <▼> keys to increase or decrease to any time from 0:00 to 30:00 minutes.
<Tone Volume> Set the volume for the sound emitted each time the patient makes the cursor hit a target.	On	Touch any section of the bar to set the volume level from 1 to 10.
<Screen Configuration> The Screen Saver setting sets the number of minutes the display remains on when the system is not in use. After the inactivity timer expires, the screen fades.	Inactive	<ol style="list-style-type: none"> 1. Touch the <▲> or <▼> keys to set the number of minutes of inactivity. 2. To activate, touch the <Enable Screen Saver> box. The box color changes to green.
The user can view the same contents of the display on an external monitor.	No external monitor	<ol style="list-style-type: none"> 1. Check that the external monitor is plugged into the system display and a power supply. Turn on the monitor. 2. Touch <Enable/Disable External Monitor>. The external monitor mirrors the display. 3. Touch <OK> to return to the Configuration screen.

Function	Default	Options
<Set Date/Time> Touch <Set Date/Time> to change the system time or date.	Eastern Standard Time (EST)	1. Touch to highlight the value being changed, and use the <▲> or <▼> keys to increase or decrease the value. 2. Touch <OK> to accept the changes and return to the Configuration screen.
<Units> The device can use either US standard or metric measurements.	US	Touch the arrow on the Unit dropdown list, and then touch the type of unit.
<Change Access ID Code> The code restricts access to certain sections of the system configuration such as default system settings and patient data.	159	1. To change the access ID code, touch the keypad icon, and enter the new code. 2. Touch <OK> to save the New Access ID Code and return to the Default Settings screen.

6. After changes have been made, touch <Back> to exit and return to the Utilities menu.
7. Touch <Back> a second time to return to the Home Menu.
8. To complete the configuration:
 - Touch <Utilities> on the Main screen.
 - At the Access ID Code screen, enter the ID code **159** and touch <OK>.
 - Touch <Configuration>.
 - Touch Balance System SD Configuration screen (see Figure 2.5).

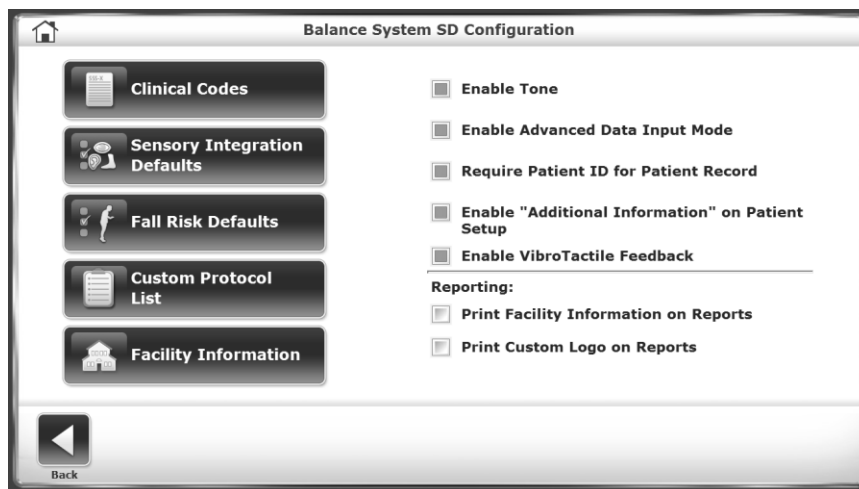

Figure 2.5. Balance System SD Configuration Screen.











Table 2.2

Balance SD Configuration Functions Table.

Function	Default	Options
<Clinical Codes>	Not applicable	Not applicable
<Sensory Integration Defaults>	mCTSIB default data No BESS data	Specify an alternative data set for mCTSIB or create BESS data-. Refer to Sensory Integration Tests.
<Fall Risk Defaults>	Refer to Error! Reference source not found..	Changing the default conditions makes the comparisons to the normative data invalid.
<Custom Protocol List>	None	Refer to Managing Custom Protocols.
<Facility Information> Information about the site.	None	Touch <Facility Information> to enter text about the site. Touch <Print Facility Information on Reports> to include site information in reports.
Enable Tone	Disabled	Touch the check box to enable audio feedback. Set the volume of the tone in <Tone Volume>.
Enable Advanced Data Input Mode	Patient Setup requires: <ul style="list-style-type: none"> • Age • Height Range 	Touch the check box to require: <ul style="list-style-type: none"> • Date of Birth • Height
Require Patient ID# for Patient Record	Patient Setup does not use a patient ID number or medical record number.	Touch the check box to require a Patient ID#.
Enable 'Additional Information' on Patient Setup	Patient Setup has an inactive Additional Info icon.	Touch the check box to enable the Additional Info icon. This allows users to further specify the patient profile with information such as Health Status, Alternate ID, Group, Sport, Facility, and Referred By. Up to four more fields can be added, customized for the site.
Enable VibroTactile feedback	Disabled. Refer to VibroTactile System.	Touch the check box if the VibroTactile System is used with the Balance System SD.
<Reporting> Enable Impairment %	None	Touch the check box to input a G-code for Patient Setup.
Print Facility Information on Reports	Disabled	Touch the check box to input information about the site that will be displayed on printed reports.
Print Custom Logo on Reports	Disabled	Touch the check box to display the logo on reports.

Common Icons and Buttons

Table 2.3. Action Table for Configuration Function Icons.

Icon	Name	Action
	Home	Returns to the Main Menu.
	Next	Advances to the next screen.
	Back	Returns to the previous screen.
	OK	Confirms changes and advances to the next screen.
	Clear Tracing	To erase the trace and start again, touch the <Clear Tracing> icon.
	Magnifying Glass	Enlarges the screen for easier viewing. After enlarging the view, the setting for the platform cannot be changed until the original view is restored.
	Keypad	Displays a window to enter numbers.
	Keyboard	Displays a window to enter text.
	Start	Begins the session and the timer starts. The current score is displayed.
	Stop	Stops the session. No more data is recorded, and the platform locks in the static position. Touch <Start> to begin another session using the same parameters.

3. Planning a Session

For a productive patient session, practice the adjustments and display selections that will be needed, and review the patient history.

Evaluating a Patient

- A postoperative patient must possess adequate muscular control to stabilize the joint. Inadequate muscular control might lead to increased joint translation.
- A patient’s supporting structures above and below the joint must have adequate strength.

Setting Up a Session

For a new patient, create a patient record. For a returning patient, retrieve the patient record.

NOTE: Specifying the patient’s height is mandatory because height is used to calculate the patient’s center of gravity (COG) when the platform is in a level, static mode. The height or weight cannot be entered or changed after a test is complete.

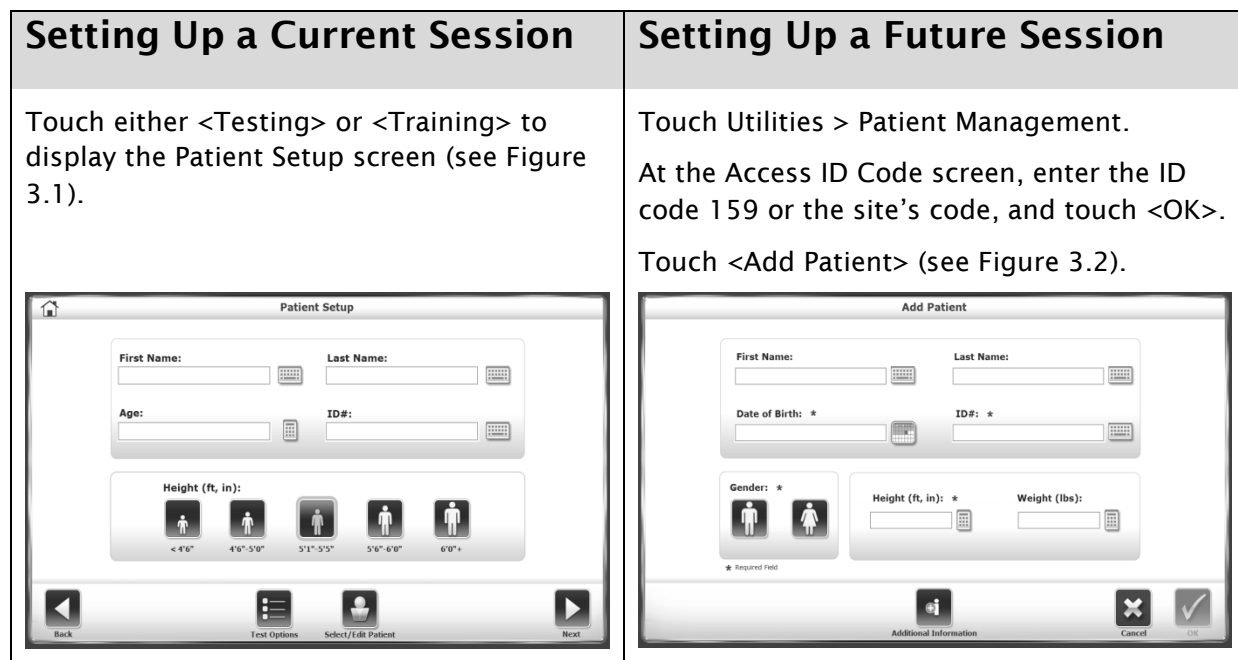

Figure 3.1. Patient Setup Screen.

Figure 3.2. Add Patient Screen.

For a New Patient:

1. Touch the keyboard or keypad icon to enter text and values in the fields.
2. If the Patient Setup screen is being used, touch the appropriate Height icon for this patient.
3. Touch the appropriate gender icon.
4. If the Additional Information icon is enabled, touch the icon to display the Additional Information screen, as illustrated in Figure 3.3. Enter the information required by the site and touch <OK>.



Figure 3.3. Additional Information Screen.

5. If Training or Testing mode has already been selected, touch <Next> to continue to specify the session; otherwise, touch <OK>.

For a Returning Patient:

1. From either the Patient Setup screen or the Add Patient screen, locate the correct patient. As illustrated in Figure 3.4, enter a name or ID number to search or scroll through the list of patients. After a search, touch the Refresh icon to return to the list of patients.



Figure 3.4. Select a Patient Screen.

2. Touch the patient record to highlight it and touch <OK>. The display is refreshed with the patient's information.
3. If the patient's height or weight has changed since the last session, touch <Edit> and enter the new value.
4. Touch <OK> or <Next>.
5. If Training or Testing mode has already been selected, continue to specify the session.

4. Getting Started

Starting a Session

- Explain the purpose and actions of the Balance System to patients before they step onto the platform so that they are not surprised when the platform moves later in the session.
- Begin each session with the platform in the static position, even if conducting a dynamic trial. By default, the Balance System starts with the platform in the static position and returns to the static position after three minutes of inactivity.
- Adjust the regular support or optional FreeSway Handles for comfort and safety. The handles protect a new or unstable patient from an unexpected movement of the platform. Patients with a fear of falling benefit from the safety of the available support from the FreeSway Handles while improving postural stability. They can then progress to performing balance training without using any handles.
- Adjust the display height so that the patient looks straight ahead at the screen. This encourages good posture and data collection.
- Position the patient's feet for center of gravity. Make sure the patient continues to stand in the center of the platform for safety and for good data collection.

Adjusting the Support Handles



CAUTION: Keep fingers away from the top start position to avoid pinching.



- Turn the knob on the front to the left to loosen.
- Pull the knob out towards you.
- Adjust the height of the handles up or down until you have reached the desired start position.
- Push the knob into the desired start position.
- Turn the knob to the right to tighten and lock into place.

Figure 4.1. Adjusting the Support Handles.

FreeSway Handles

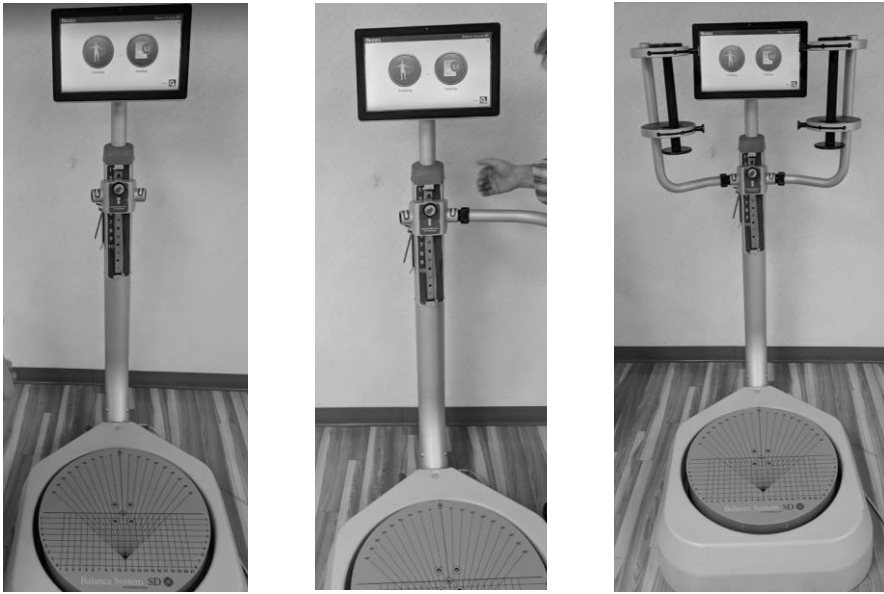

Figure 4.2. Adding the FreeSway Handles.

The handles can now be interchanged between the FreeSway and regular support handles.

- Spin the black connectors to the left to remove handles.
- Insert and spin black connectors to the right to attach the FreeSway Handles.



Figure 4.3. Adjusting the FreeSway Handles.

The FreeSway Handles, when secured on the Balance System SD, become a stable platform. This assists users with balance impairments to cope with their fear of falling, while safely and independently performing exercises to improve their function.

NOTE: This unit can be used with therapist assistance.

The FreeSway handles have three challenge settings.

- Level A has the most movement excursion and provides the greatest challenge during balance testing and training.
- Level B has less movement excursion than level A.
- Level C has the least amount of mobility; it provides the least amount of challenge during balance testing and training.

To adjust the Challenge Level, or degree, of the opening:

- Pull out the knobs and slide to adjust the opening position for the desired amount of float.
- Push the knobs back in to lock.

Adjusting the Display



- Turn the knob on the back of the support post to the left to loosen.
- Pull the knob out towards you.
- Adjust the display height up or down until you have reached the desired start position.
- Push the knob into the desired start position.
- Turn the knob to the right to tighten and lock into place.

Figure 4.4. *Adjusting the Display.*

Positioning the Patient's Feet

1. Have the patient stand in a natural stance on the static platform. The Position Patient screen displays the patient's center of gravity as a dot (see Figure 4.5).
2. Adjust the patient's foot placement until the dot is on or close to the center axis.
3. Using each of the four keypads, enter the patient's left foot, left heel, right foot, and right heel positions using the midline of the foot and the grid on the platform as reference points.

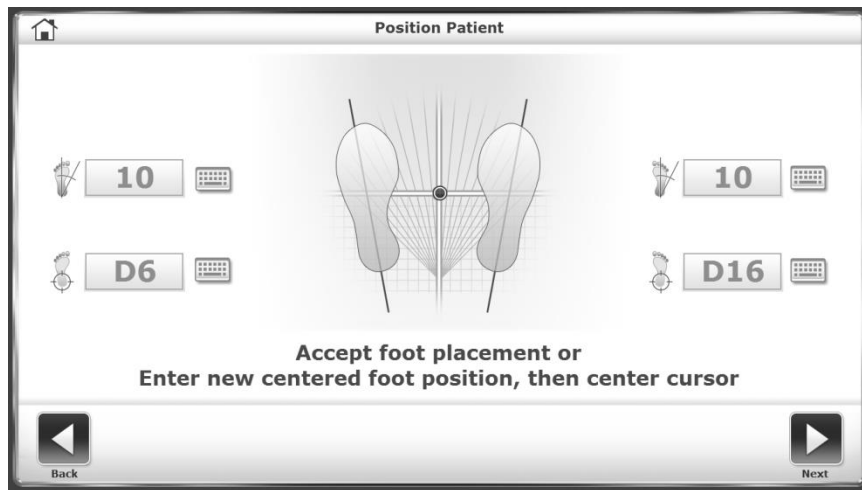

Figure 4.5. Position Patient Screen.

4. Use Table 4.1 to estimate the foot placement based on the patient's height.

Table 4.1 Estimates for Foot Placement.

Height Default		Foot Angle	Heel Position
< 53 in.	<1.34 m	10/10	F7/F15
53 - 59 in.	1.34 - 1.49 m	10/10	E7/E15
59 - 65 in.	1.49 - 1.65 m	10/10	D67/D16
65 - 73 in.	1.65 - 1.85 m		
>73 in.	>1.85 m	10/10	C5/C17

Common Actions

- Choose Training or Test mode from the Home screen (see
-
-
- Figure 2.1).
- Locate the patient record. Specify the patient's height, either an estimate or the actual height (see Setting Up a Session).
- Specify the characteristics of the training or test (Refer to Setting Up a Training Session or Setting Up a Test Session).

Setting Up a Training Session

Patients should experience preliminary trials before a test session. Clinical research suggests completing three trials before a test.

- Touch <Training>, <training mode > and <Next>.

OR

- Touch <Test Options>.

The display displays the Test Options screen for the selected training mode.

1. Touch <▲> or <▼> to set the total Trial Time. The system counts down from this time. If a time is not set, the system counts elapsed time.
2. Change or accept the movement range for scoring.
3. Enable or disable Tone for audible feedback.
4. To enable the display of the cursor, touch the check box.
5. To enable the display of tracing biofeedback, touch the check boxes.
6. Touch <Next>.
7. Position the patient on the platform.
8. Touch <Start>.

Note: During the session, the settings for platform stability, skill level, time, and target or movement orientation can be adjusted.

Setting Up a Test Session

The settings for a test session are more constrained than for a training session because the results are compared to normative data sets.

- Touch Testing > test name > Next.

OR

- Touch <Test Options>.

The Test Options screen for the specified test is displayed.

1. Touch <▲> or <▼> to set the total Test Trial Time. During the test, the system counts down from this time.
2. Specify conditions for the test, such as sensory conditions.
3. Set the Number of Trials. Touch the keypad icon and enter the number.
4. Set the Rest Countdown, the time between trials. Touch the keypad icon and enter the number.
5. To include the patient's foot position in the test data, touch the Record Foot Position check box.
6. Position the patient, including foot placement.
7. Touch <Start>.

-
8. Between each trial, the system pauses for the time set for Rest Countdown.
 9. After completing all trials, a “Test Complete” message is displayed. Touch <Results>.

Saving Results and Creating Reports

1. To save the test data, touch <Save Results> and touch <OK>. The system displays “Save Results Completed.” If this test result is not saved, the system prompts to confirm.
 - Touch <Print> to generate the report for the test.
 - To save a PDF file of the test report, insert a flash drive into one of the USB ports on the display. Touch <Export PDF>. The PDF file is copied to a new folder named BioReports on the flash drive. If more files are saved to this flash drive, the files are named uniquely.

5. Training Modes



CAUTION: Always supervise the patient. When patients are working with their eyes closed, be ready to assist in case they lose their balance.

Percent Weight Bearing Training

Percent Weight Bearing Training displays the percentage of weight-bearing force on a patient's foot, ankle, knee, hip, and body side. Targets are set to encourage patients to place weight in anterior, posterior, medial, and lateral movements. In this mode, the platform is static. The patient sees the axes in green when weight bearing is within targets. The score is the percentage of time the patient was within the target range.

1. Touch one of the three Axis icons to select the orientation for training. The display changes to show only that axis. Figure 5.1 displays both axes.

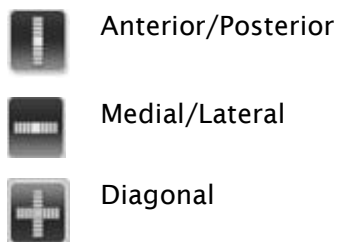

2. Set targets for each direction of the orientation. For finer control for setting targets, first touch <Magnify>.
 - a. Touch the maximum line to select. The line color changes from red to green.
 - b. Touch the new location for the maximum target. The line color changes to red.

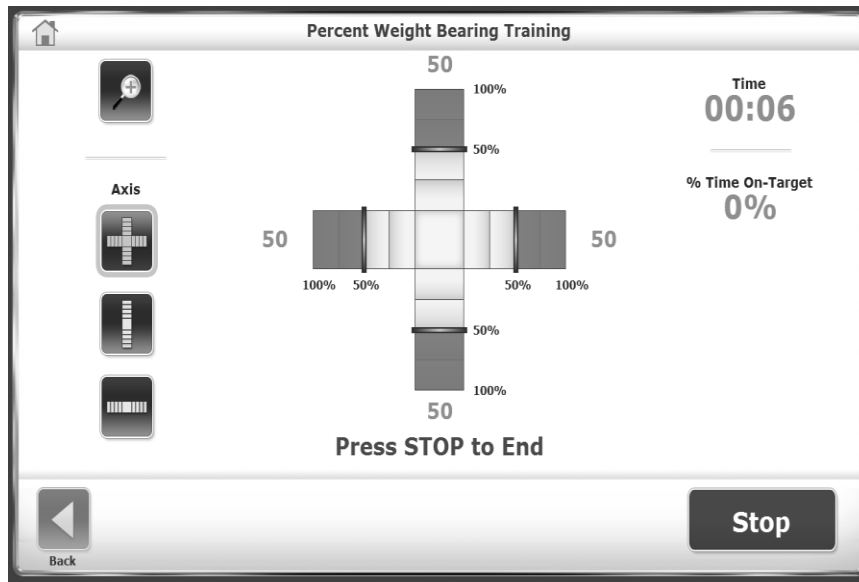

Figure 5.1. Percent Weight Bearing Training.

Weight Shift Training

Weight Shift Training allows patients to practice shifting their weight in medial/lateral, anterior/posterior, or diagonal directions. This can be performed with the platform static or dynamic. The user sets the orientation and the target range. The patient attempts to keep the center of gravity indicated by the cursor within the target box (see Figure 5.2).

Scoring is a percentage of the net good hits divided by the total target hits. All hits outside the boundary are subtracted from the total target hits. This value equals the net good hits. If the cursor crosses a red boundary, a hit is subtracted from the good hit total.

For example: if a patient achieved ten target hits, but allowed the cursor outside the boundary four times, then this training has $10 - 4 = 6$ good hits and the score = $6/10$ or 60%.



Figure 5.2. Weight Shift Training.

1. Set the length of time for the training session.
2. Set the resistance level of the platform: Static or 1 through 12.

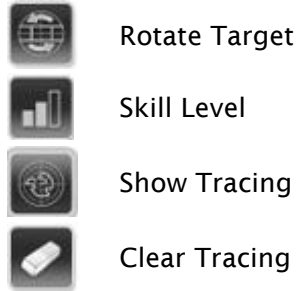

3. Touch <Rotate Target> repeatedly to show each orientation, and display the target for this training session.
4. Touch <Skill Level> repeatedly to show each size target box. The widest target box area requires the lowest skill level.
5. Change the resistance level by touching the line and touch a new level.

Postural Stability Training

In the Postural Stability Training mode, patients practice specific movement patterns or strategies. Select one of the following approaches:

- Place targets anywhere on the screen grid. The patient leans and shifts to make the cursor touch each target. The score is the total of touched targets.
- Set a ring or boundary. The patient balances to keep the cursor within the boundary of the ring. The score is time within the boundary.

Only one approach can be selected in a session (see Figure 5.3).

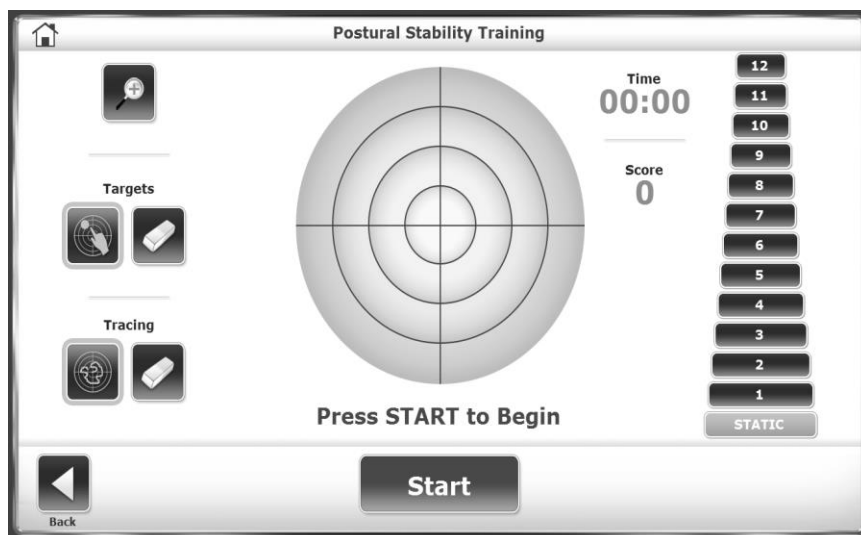

Figure 5.3. Postural Stability Training.

1. Set the resistance level of the platform: Static or 1 through 12.
2. Set the length of time for the training session.

3. Touch Place Target icon, and then touch a location on the screen. For different shapes of targets, touch <Targets>. Place up to nine targets.

OR:

1. Touch <Targets> repeatedly to select one of the three target areas.
2. To clear an unwanted target, touch Clear Target icon, and then touch the target. To clear more targets, touch <Clear Target> for each target.

Motor Control Training

The Motor Control Training mode challenges the patient to use the sway envelope, which is the range a person can move the center of gravity (COG) within the base of support. The COG is approximately 8 degrees to one side and 8 degrees to the other side for a total of 16 degrees of sway, and 8 degrees forward and 4 degrees back for a total of 12 degrees of sway.

A pattern of targets is displayed. One target blinks. The patient must move the cursor from the center target to the blinking target and back to the center target (see Figure 5.4).

Scoring is a percentage of movement outside the sway envelope and measures the precision of the movement. The straighter the movement, the better the stability. For example, if the shortest distance from the center target to perimeter target was an excursion of 8 degrees and a patient swayed 16 degrees, the score is 50%.

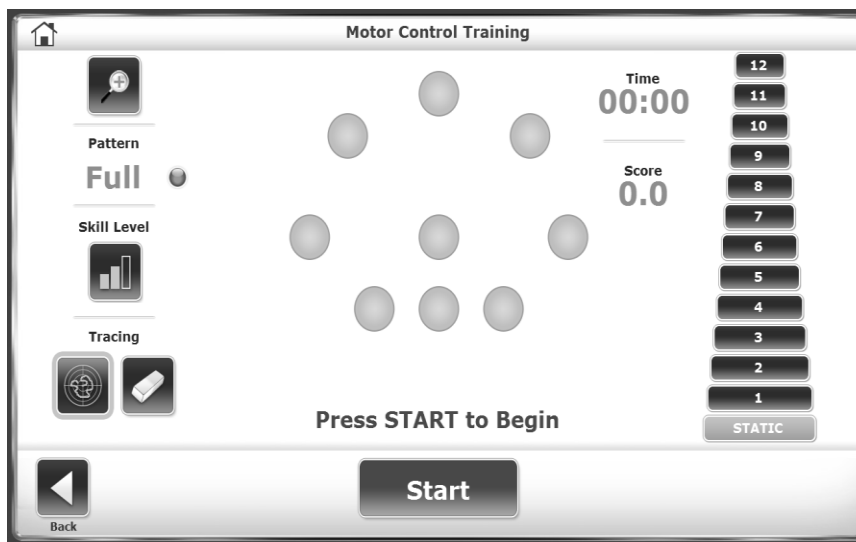

Figure 5.4. Motor Control Training.

1. Set the length of time for the training session.
2. Set the resistance level of the platform: Static or 1 through 12.
3. Touch <Pattern> to toggle between Full, Left, or Right target set orientation.
4. Touch <Skill Level> to narrow or widen the space between targets. The lowest skill level sets the targets close together.

Maze Control Training

In Maze Control Training mode, the patient follows a sequence of targets through a maze.

The patient moves the cursor to each target as it blinks but must not let the cursor touch a wall of the maze (see Figure 5.5).

Scoring is a percentage of the net good hits divided by the total target hits. All hits outside the boundary are subtracted from the total target hits. This value is the net good hits. For example: if all the targets are cleared on the easiest maze but the maze wall is hit 6 times, the score is 20/26, or 77%.

1. Set the length of time for the training session.
2. Set the resistance level of the platform: Static or 1 through 12.
3. Touch <Skill Level> until the desired configuration is displayed:
 - a. Easiest maze has 26 targets; 13 in each direction.
 - b. Moderate has 52 targets; 26 in each direction.
 - c. Difficult has 74 targets; 37 in each direction.



Figure 5.5. Maze Control Training.

Random Control Training

In Random Control Training mode, the patient responds to random movement of a target. The target is a red circle that starts in the center of the grid and moves in random directions. The clinician sets the size of the target and the speed of its movement. The patient moves the cursor to keep it within the target (see Figure 5.6).







1. Set the length of time for the training session.
2. Set the resistance level of the platform: Static or 1 through 12.
3. Touch <Skill Level> repeatedly to increase or decrease the size of the target.
4. Touch <Circle Speed> to rotate through three speeds. The single green circle is the slowest speed and requires the lowest skill level.



Figure 5.6 Random Control Training.

6. Testing Modes

The Balance System SD runs and records the following tests (see Figure 6.1).

-  Sensory Integration (mCTSIB, BESS)
-  Postural Stability
-  Bilateral Comparison. Postural stability performance of standing on one leg versus standing on the other
-  Limits of Stability
-  Motor Control
-  Fall Risk
-  Custom protocol. The steps for customizing a protocol are listed in the System Utilities section of this document

Each test can be run with a static or a dynamic platform.

For a static test, the device measures the angular excursion of the patient's center of gravity (COG), which is calculated from the patient's height. COG is approximately 55% of height.

In a dynamic test, the variance of the platform angle from the platform's level position is measured, as well as degrees of deflection over time. This data illustrates the patient's ability to control balance.



CAUTION: Always supervise the patient. When patients are working with their eyes closed, be ready to assist in case they lose their balance.

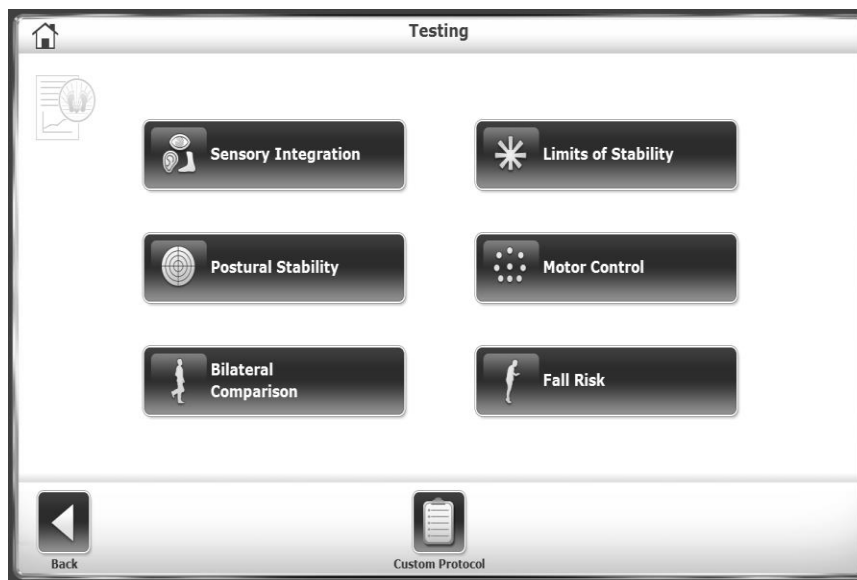

Figure 6.1 Testing Protocols.

Many of the actions of the Testing mode operate the same as in Training mode. Differences between the testing options are:

- Tests require a time limit.
- Tests include sensory conditions, the number of trials, and a rest countdown, which is the time between test trials.
- Tests can record foot position.

The Test Options screen includes these selections.

- To set the Number of Trials or Rest Countdown, touch the appropriate key and enter the setting using the pop-up keypad.
- To have the patient record a foot position for the test, touch the check box next to Record Foot Position.

After completing all trials, a “Test Complete” message is displayed. Touch <Results> to advance to the Test Results screen. If a patient cannot complete a trial, the data reports DNC (Did Not Complete) on the results screen and report.

Sensory Integration Tests

Touch <Sensory Integration> to view the available tests, including custom tests. Custom tests are based on either the mCTSIB or BESS test.

- Use the indexed foam pad on the platform for the dynamic surface test conditions.
- To test visual conflict conditions, provide the patient with eyeglasses that create a distorted yet transparent image. For example, modify clear safety glasses to mar the lenses or cover them with clear adhesive tape.

Clinical Test of Sensory Integration of Balance (CTSIB)

The Clinical Test of Sensory Interaction of Balance (CTSIB) is a standard test for balance assessment on a static surface. The test assesses how well a patient can integrate sensory information to maintain balance. The result of the CTSIB test is the patient’s sway index, which represents the mean absolute deviation of the patient’s average position during a test. The higher the sway index, the more unsteady the person was during the test.

The test changes a sensory condition and measures how well the patient compensates. Table 6.1 lists the six CTSIB conditions. However, the Biodex Balance System SD uses the modified CTSIB (mCTSIB) test, which tests only conditions 1, 2, 4, and 5, as illustrated in Figure 6.2. Create a custom protocol to test conditions 3 and 6.

Table 6.1. CTSIB Conditions.

Surface	Visual	Input
Firm	Eyes open	Baseline condition: Input is visual, vestibular, and somatosensory.
	Eyes closed	Evaluates vestibular and somatosensory inputs.
	Conflict	Some visual input but it conflicts with vestibular input. Condition relies on vestibular and somatosensory inputs.
Dynamic	Eyes open	Evaluates somatosensory interaction with visual input.
	Eyes closed	Evaluates somatosensory interaction with vestibular input.
	Conflict	Evaluates the mediation of visual with vestibular and somatosensory inputs.

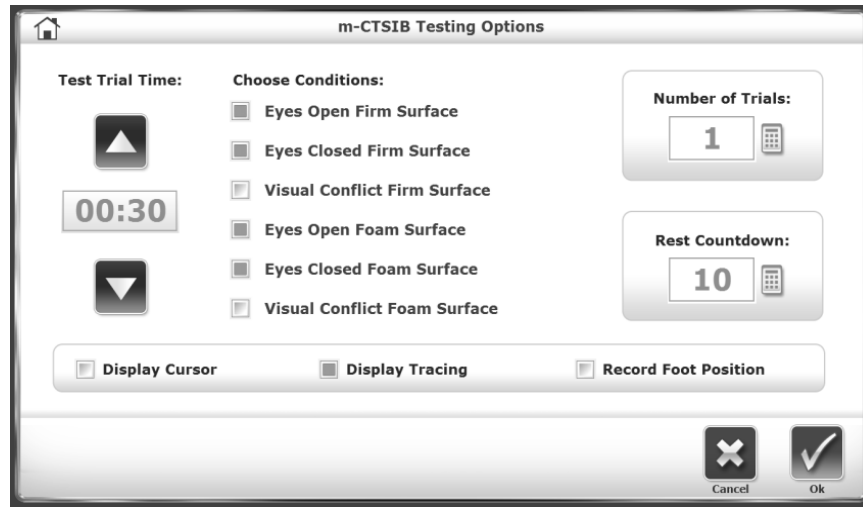

Figure 6.2. Testing Options for mCTSIB.

Balance Error Scoring System (BESS)

The Balance System SD uses an enhanced BESS test. In a conventional BESS test, scoring is based on time and number of errors, which requires the evaluator's judgment. With the Balance System SD, time and error counting is replaced with a measure of sway. Errors can be noted, but they do not affect the score.

A test consists of three positions on two types of platforms for a total of six conditions. Some conditions can be excluded (see Table 6.1).

1. Touch the check boxes next to the conditions to include the condition in the test.
2. To note errors (e.g., the patient grabs the support handle), touch the check box next to <Error Scoring> to count the error.

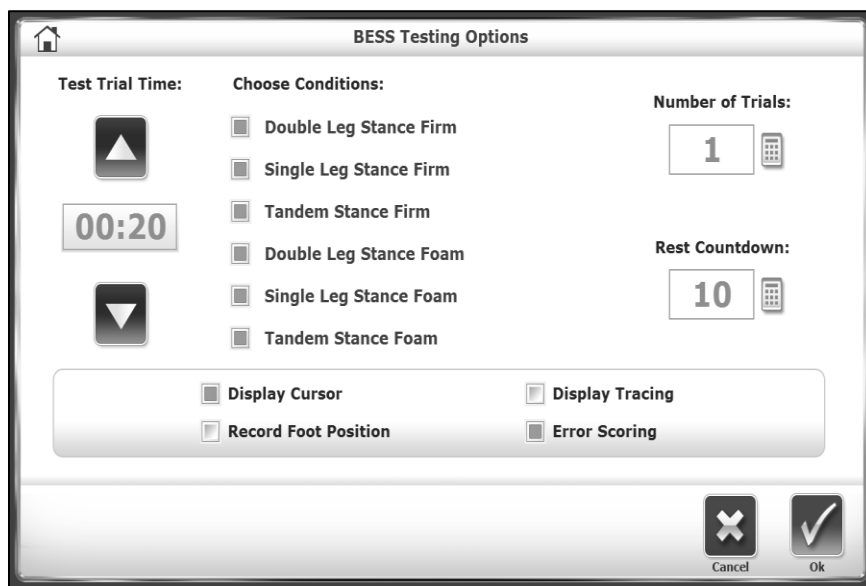

Figure 6.3. Testing Options for BESS Test.

Limits of Stability (LOS) Test

The LOS test challenges patients to control their center of gravity within the base of support.

The LOS test measures how far from the center the patient can sway. The angle of sway is the number of degrees from the position of the patient's center of gravity (0 degrees). The estimated COG is 55% of the patient height.

The LOS test is a good indicator of motor control within a sway envelope. Poor control, inconsistent, or increased times suggests assessment of lower extremity strength, proprioception, and vestibular or visual deficiencies (see Figure 6.4).

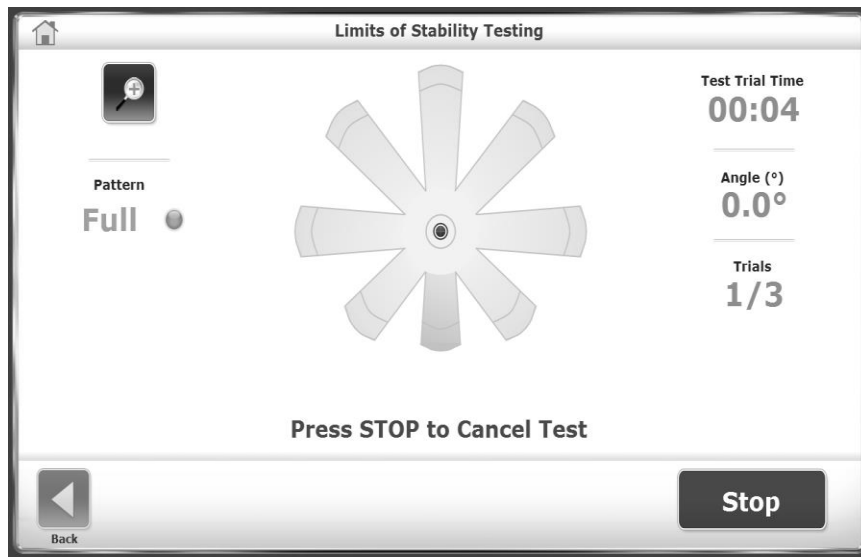

Figure 6.4. Limits of Stability Test.

1. During each trial, patients must shift their weight to move the cursor from the center along a target path and back to center as quickly and with as little deviation as possible. After completing a target path, the patient returns the cursor to center and holds for three seconds before the next target path appears. Target paths activate in a random order.
2. A trial is finished when the patient completes all paths or the time limit is met. After each trial, the screen displays a ten-second countdown to enforce rest before the next trial.
3. Touch <Collect Data> to begin the next trial.

Postural Stability Test

The Postural Stability test assesses a patient's ability to maintain a center of balance. It measures how much the patient's position deviates from center and reports the average deviation as the stability index. Therefore, a low score is more desirable than a high score.

Consider the following example:

If a patient is in an off-center position on the platform, the stability index has a large value. However, if the patient swayed very little, the standard deviation is low. This is evident when viewing the tracing, if it enabled. A patient could have a score of 6.5, yet the standard deviation could be only 0.8. The tracing displays the patient did not sway very much. However, if the patient swayed a lot, the standard deviation is higher. Thus, the standard deviation is indicative of sway.



Figure 6.5. Postural Stability Test.

During each trial, patients must hold their position to keep the cursor in the center. After each trial, the screen displays a ten-second countdown to enforce rest before the next trial.

1. Touch <Test Options>.
2. Touch <▲> or <▼> to select a time, ranging from 0.25 to 5 seconds.
3. Set the resistance level of the platform: Static or 1 through 12.
4. Touch <Collect Data> to begin the next trial.

Motor Control Test

The Motor Control test measures how patients control their center of gravity within a base of support. Like the Limits of Stability test, patients shift their weight to move the cursor from the center target to a blinking target and back as quickly and with as little deviation as possible. The same process is repeated for each of the targets. Targets on the screen blink in random order. Three skill levels allow the targets to be grouped closer together or spread further apart, and the platform setting can be static or dynamic (see Figure 6.6).

This test is a good indicator of dynamic control within a sway envelope. Poor control and inconsistent or increased times suggest assessment for lower extremity strength, proprioception, vestibular, or visual deficiencies.

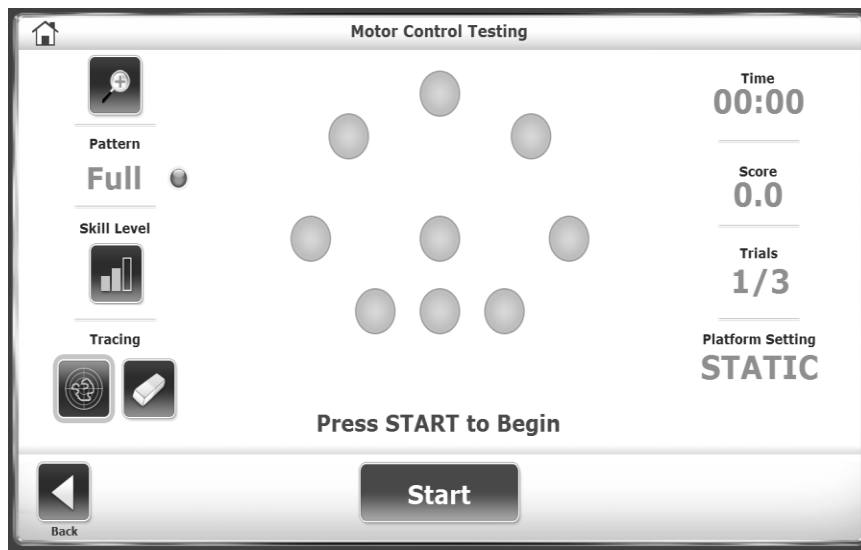

Figure 6.6. Motor Control Test.

1. Touch <Test Options> to set the Motor Control Hold Time.
2. Touch <▲> or <▼> to select a time, ranging from 0.25 to 5 seconds.
3. At the Motor Control Testing screen, touch the blue <Pattern> icon repeatedly to rotate through the options: Full, Left, and Right target orientations.
4. Touch <Skill Level> repeatedly to rotate through the options: Easy, Moderate, or Difficult target orientations. The Difficult level has the farthest target spread. The Moderate level is the default skill level.

Bilateral Comparison Test

In a Bilateral Comparison test, the patient stands on one leg in the middle of the platform for a set time and at a set stability level. The patient performs the same test standing on the other leg. Clinicians compare data from each test to determine treatments for the weak leg.

Each trial consists of two tests: left leg and right leg. During each trial, patients must hold their position to keep the cursor in the center.



Figure 6.7. Bilateral Comparison Test, Left.

1. Touch <Test Options>.
2. Touch <▲> or <▼> to select a time, ranging from 0.25 to 5 seconds.
3. Set the resistance level of the platform: Static or 1 through 12.
4. Touch <Collect Data> to begin the next trial.

Note: After each trial, the screen displays a ten-second countdown to enforce rest before the next trial.

5. Touch <Collect Data> to begin the next trial.

Fall Risk Test

The Fall Risk test identifies potential fall candidates. The test measures the patient's postural sway velocity to predict risk. Velocity is the speed of an individual's sway as balance is maintained.

Test results are compared to age-dependent normative data. A high sway velocity when a patient is attempting to stand motionless suggests a deficit in postural control and assessment for lower extremity strength, proprioception, and vestibular or visual deficiencies.

NOTE: One condition of the Fall Risk test is conducted with the patient's eyes closed and another condition is conducted with the patient in a narrow stance. Never leave the patient unattended.

For tests in a narrow stance (see Figure 6.8), position the patient so that the space between their feet is 2.95 in. (7.5 cm). On the platform grid, place each foot two blocks away from the AP midline with the navicular tubercle over the ML midline.

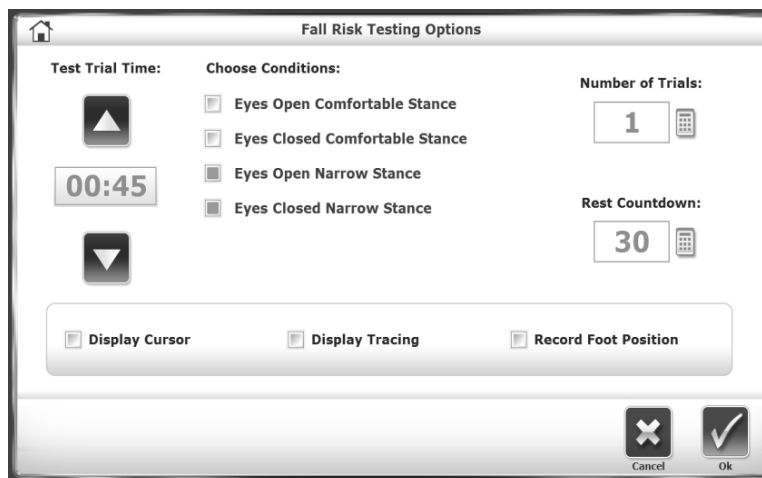

Figure 6.8. Testing Options for Fall Risk Test.

7. Utilities

The Utilities screen displays the system's firmware version and provides access to the Reports, Configuration, Patient Management, and System Maintenance screens, as illustrated in Figure 7.1.

The platform can be locked at any time. Touch <Lock Platform> to make the platform level and firm. It is always level and firm in static mode and returns to this mode after three minutes of inactivity. The platform remains locked until a new trial or test is started.

Touch <Utilities> on the Main screen.

- 1. At the Access ID Code screen, enter the ID code **159** or the site's code, and touch <OK>.

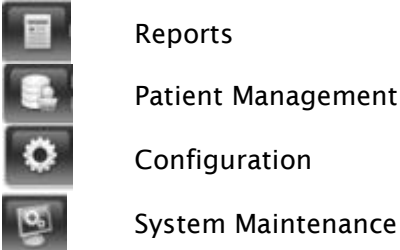

Figure 7.1. Utilities Menu.

Reports

Use reports to analyze and present test results. If the patient has multiple tests, results can be compared as a progress report. The reports can be viewed or printed in PDF format.

NOTE: From the Reports screen, codes or comments cannot be edited. Instead, select <Utilities>, <Patient Management>.



- View** Used to view the selected report.
- New Test** Used to return to the Test Menu to start a new testing session.
- New Training** Used to return to the Training Menu to start a new training session.
- Repeat** Used to repeat the selected test/training.
- Print** Used to print the report.

Creating a Report for Results

1. Touch <Reports>, select the patient record, and touch <Next> (see Figure 7.2).

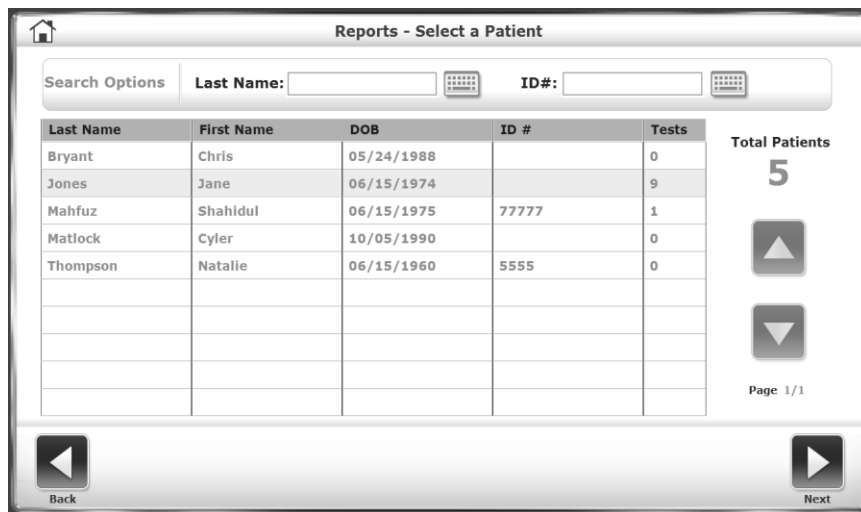

Figure 7.2. Selecting a Patient for a Report Screen.

2. The list of sessions is sorted by date and type. Touch a session to highlight it and touch <Next>. The Reports - Test Results screen is displayed (see Figure 7.3).

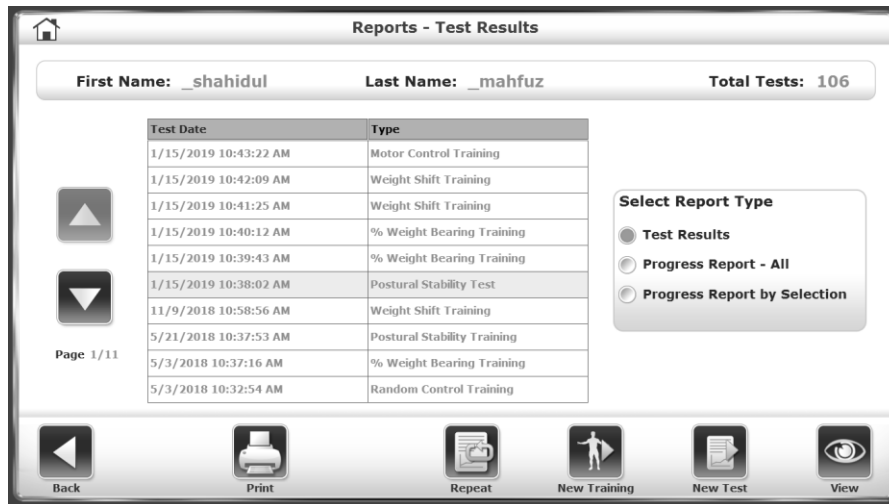

Figure 7.3. Selecting a Test for a Report.

The session can be viewed or printed. The <Repeat> button can be used to perform another session with the same settings as the highlighted session. The <New Training> and <New Test> buttons can be used to start a brand new session using the default settings. Three Report Types are available: Test Results, Progress Report – All, or Progress Report by Selection

If a test result is viewed, the system displays the Stored Test Results screen (see Figure 7.4). The results can be printed, a progress report of results from all sessions can be created, or a new session that repeats the test can be started (see Printing a Report and Creating a Progress Report).

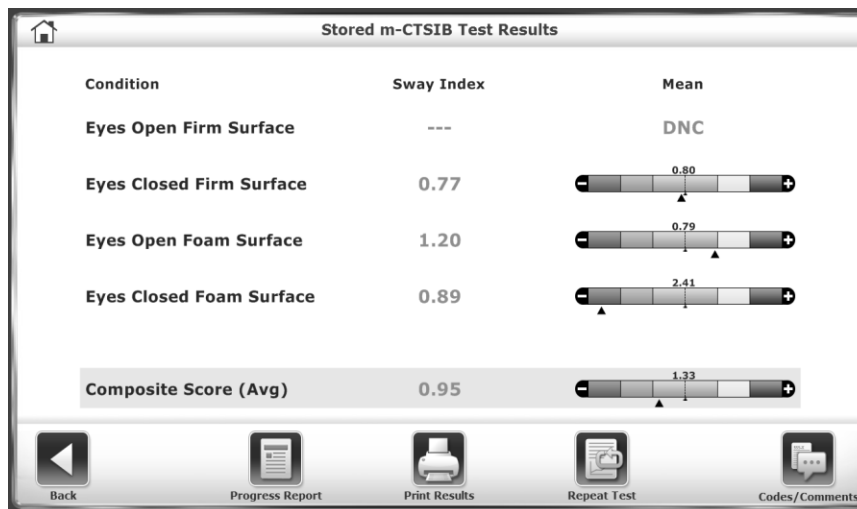

Figure 7.4. Viewing a Report.

Printing a Report

1. Touch <Print Results> to display a preview (see Figure 7.5).

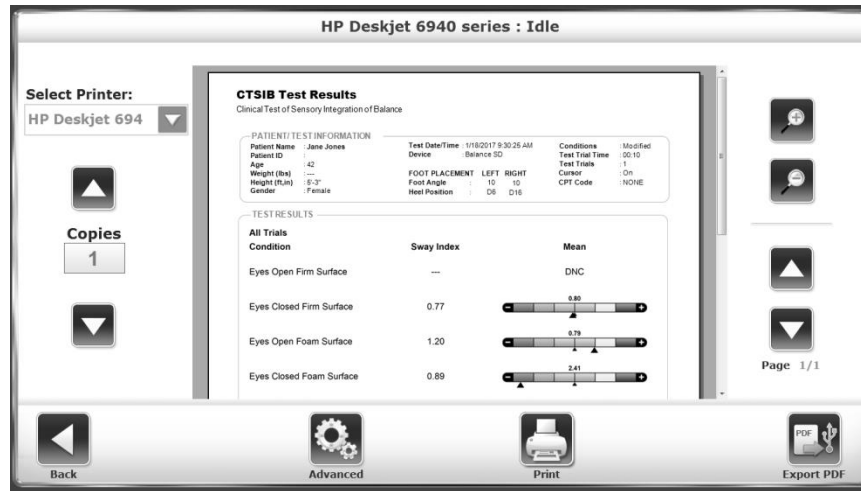

Figure 7.5. Print Preview of Test Results.

2. Touch the <Magnifying Glass> icons to zoom in (+) or zoom out (-) to increase or decrease the size of the print preview.
3. Touch <▲> or <▼> to navigate through the pages.
4. The default printer is the printer attached to the Balance System. If a network printer is available, it can be selected. Multiple copies can be printed.
5. Touch <Advanced> to display a Windows screen. Select options to refine the report.

Creating a Progress Report

Progress Report creates a graph of the data points of CTSIB tests over time against normative data or not (see Figure 7.6).

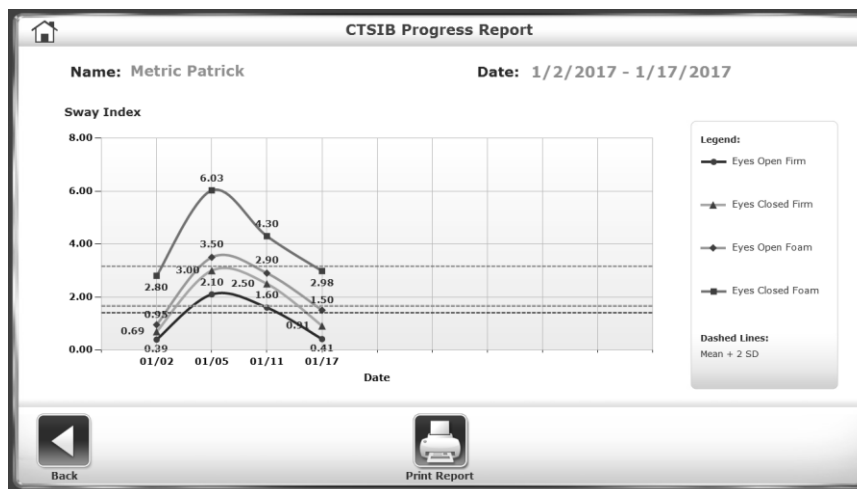

Figure 7.6. Viewing a Progress Report.

1. Touch <Reports>, select the patient, and touch <Next>.

2. On the Test Results screen, select the test. Touch <Progress Report>.
3. Touch <View>.
4. On the Progress Report Selection screen, select a maximum of four conditions to include in the report (see Figure 7.7).

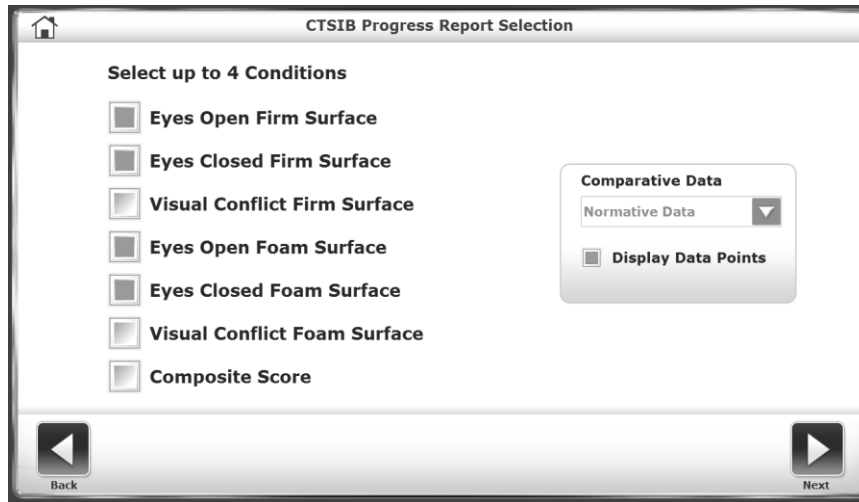

Figure 7.7. *Selecting Conditions for a Progress Report.*

5. Set the type of Comparative Data. The default is normative data. If a baseline test is available, a percentage over the patient's baseline score can be selected (see Figure 7.8).

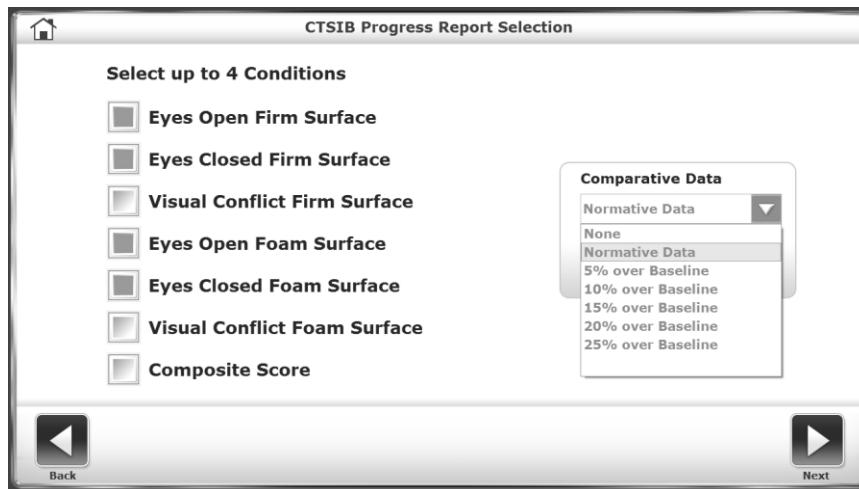

Figure 7.8. *Selecting Data for a Progress Report.*

6. For Normative Data, select a specific data set, and then touch <Next> (see Figure 7.9).

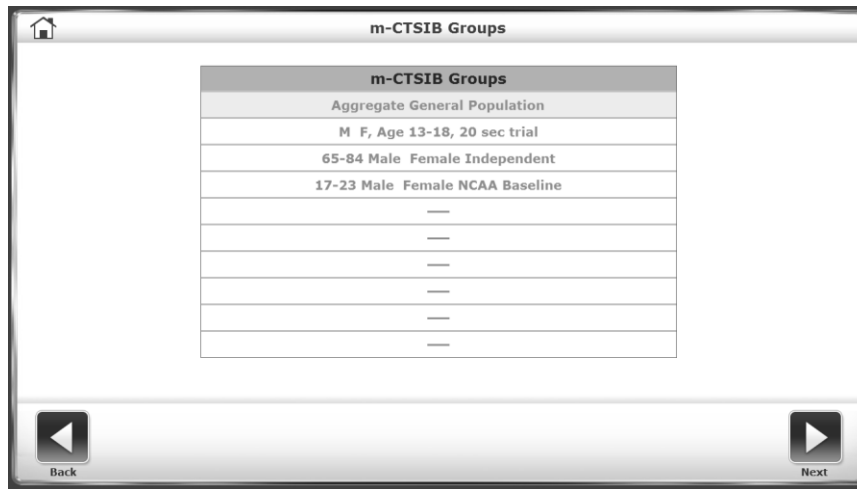

Figure 7.9. *Selecting a Data Set for a Progress Report.*

7. The Progress Report displays a graph of the data. Touch <Print Report> to display options for printing.

Configuration

The Configuration screen includes two options: System Configuration and Balance System SD Configuration.

System Configuration

Use System Configuration to select display options and to set values for actions (Refer to Configuring the System).

Balance System SD Configuration

Use Balance System SD Configuration to configure the system in detail (Refer to Configuring the System for general information about this screen). This section describes how to edit clinical codes and facility information and create custom protocols.

Change Sensory Integration Defaults

The normative data in both sensory integration tests (mCTSIB and BESS) can be specified to each facility's needs (see Figure 7.10). Only mCTSIB default data is provided. Users must enter their own default BESS normative data.

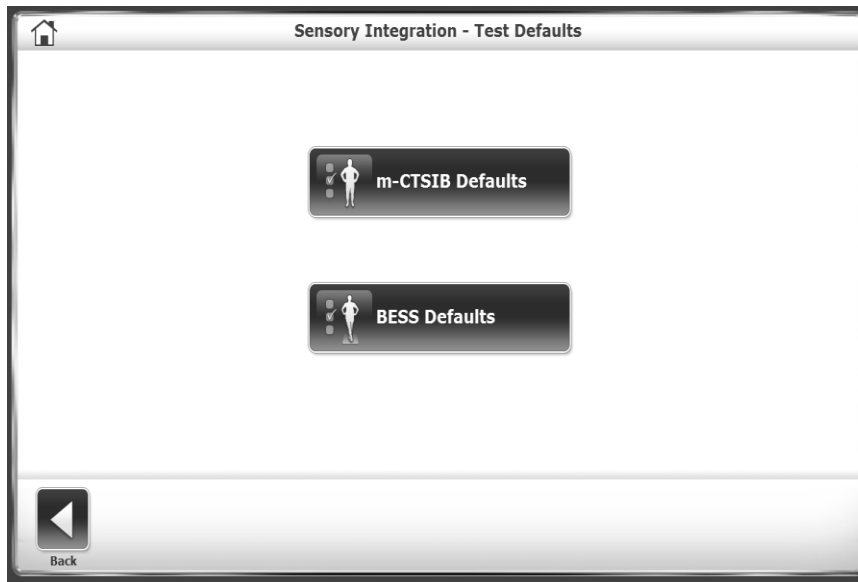

Figure 7.10. Specifying Default Data for Sensory Integration Tests.

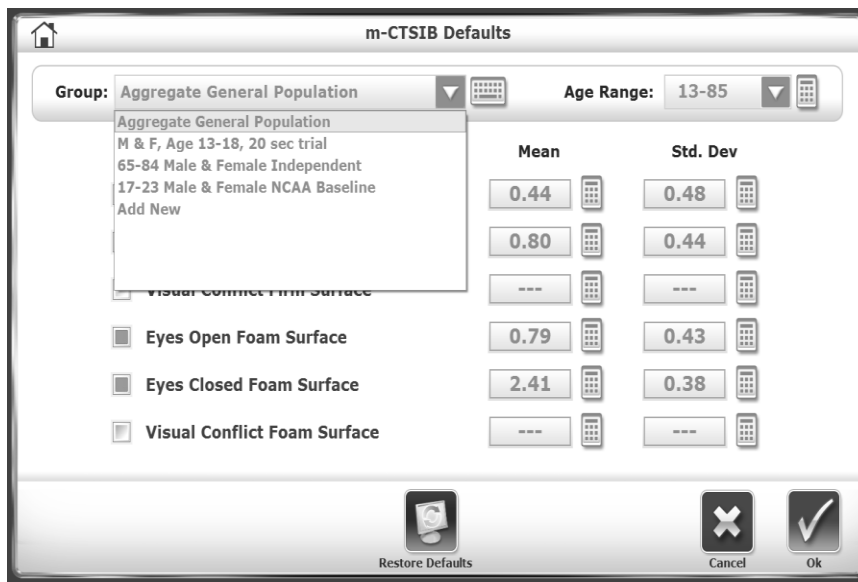

Figure 7.11. Specifying Default Data Sets for Sensory Integration Tests.

For each type of test, touch the Group and Age Range drop-down menus to make changes or add a new group (see Figure 7.11). Select the keypad icons beside each row to edit the normative data for that group. Touch <Restore Defaults> to reset the normative data to the factory setting.

Changing Fall Risk Defaults

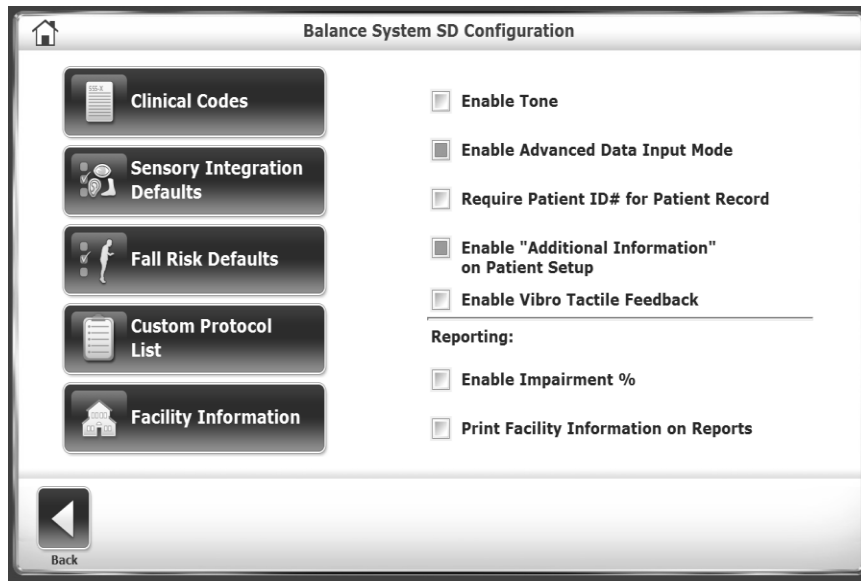

Figure 7.12. Specifying Default Settings and Data for Fall Risk Tests.

Use Fall Risk Defaults to change the default settings and associated normative data (see **Error! eference source not found.** for the default settings).

Note: Changing the default conditions will make comparisons to the default normative invalid.

Creating Custom Protocols

Use Custom Protocol List to add, edit, or delete customized testing or training protocols (see Figure 7.13).

Managing Custom Protocols

Training and testing protocols can be created for a specific purpose. After a protocol is created, it can be accessed from the main Training and Testing menus.

Creating a New Protocol

1. At the Main screen, touch <Utilities>.
2. At the System Utilities screen, touch <Configuration>.
3. Select <Balance System SD Configuration> from the Configuration screen submenu.
4. Select <Custom Protocol List> from the Balance System SD Configuration submenu.
5. The Custom Protocol list is displayed (see Figure 7.13).
6. Touch <Add Protocol>.

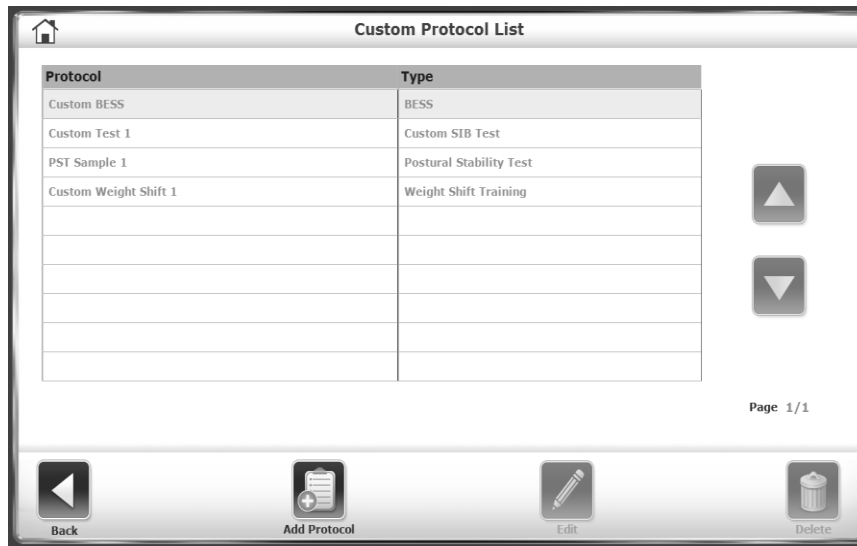

Figure 7.13. Custom Protocol List Screen.

7. Touch either <Training> or <Testing>. The procedure for creating the protocol is the same.
8. Configure the new protocol the way a standard Training or Testing session is set up. However, in this mode, there is no <Start> icon. Instead, touch <Test Options> to further specify the new protocol. An example is illustrated in Figure 7.14.



Figure 7.14. Specifying Options for a Custom Protocol.

7. When finished, touch <Save Protocol>.
8. Enter a name for the protocol to be displayed in the Custom Protocol List.

NOTE: Use <Edit> to change only Custom Sensory Tests.

Selecting a Custom Protocol

1. To select a custom protocol, touch <Custom Protocol> from either the Training or Testing menu screens.
2. Select the protocol from the list of custom protocols and proceed with the training or testing.

Deleting a Custom Protocol

1. At the main screen, touch <Utilities>.
2. At the System Utilities screen, touch <Configuration>.
3. Select <Balance System SD Configuration> from the Configuration screen submenu.
4. Select <Custom Protocol List> from the Balance System SD Configuration submenu.
5. The Custom Protocol list is displayed.
6. Touch the Custom Protocol row to be deleted.
7. Touch <Delete>.
8. Touch <OK> to confirm or touch <Cancel> to return to the Custom Protocol List screen.

Managing Custom Sensory Tests

If the mCTSIB and BESS tests cannot be customized adequately to meet requirements, a custom protocol specifically for sensory testing can be created.

Custom Sensory Tests are not accessed using the <Custom Protocols> icon on the Testing screen. Instead, each Custom Sensory Test has a separate icon on the Sensory Testing submenu, after the mCTSIB and BESS icons.

Creating a Custom Sensory Integration Test

1. At the main screen, touch <Utilities>.
2. At the System Utilities screen, touch <Configuration>.
3. Select <Balance System SD Configuration> from the Configuration screen submenu.
4. Select <Custom Protocol List> from the Balance System SD Configuration submenu.
5. Touch <Add Protocol>.
6. Touch <Testing> on the Protocol Setup screen.
7. Touch <Sensory Integration>.
8. Touch <Custom Sensory Integration> (see Figure 7.15).

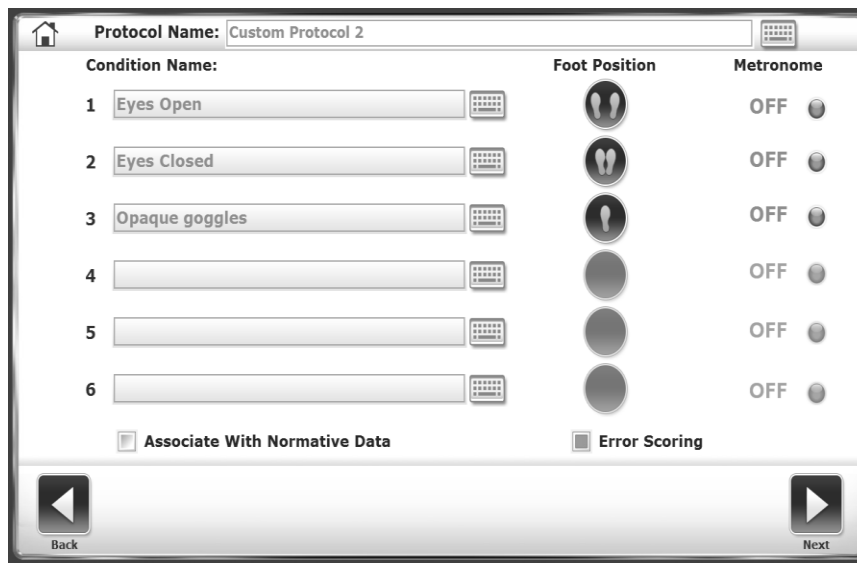

Figure 7.15. Specifying a Custom Sensory Integration Test.

9. Touch the Protocol Name field, and use the pop-up keypad to name the new protocol.
10. Touch the Condition Name fields, and use the pop-up keypads to add conditions.
11. Touch the <Foot Position> icon next to each condition to specify a regular stance, narrow base of support, single leg (left or right), or tandem straight.
12. Touch the <Metronome> field to select a time interval if using a vestibular ocular reflex challenge (head shake). The frequency can be 1, 2, or 3 Hertz per second for a 30-degree rotation from facing forward in both directions (60 degrees total).
13. Touch the Associate with Normative Data check box to connect this protocol with a data set. The square changes color to green when active. One of the provided normative data sets can be selected or a new data set can be added.
14. For a custom BESS test, touch <Error Scoring> to enable error reporting.
15. Touch <Next> to access the Custom Protocol Overview screen. This screen has options specific to the type of test and to enable tracing during the session.
16. Touch <More Options> to access the Options screen. The Test Trial Time, Number of Trials, or Rest Countdown can be selected, and one or more of the conditions can be deselected.
17. Touch <OK> to return to the Protocol Overview screen.
18. Touch <Save Protocol> to save the new protocol.

To Confirm the New Protocol:

1. Touch <Home> from the Custom Protocol Overview screen.
2. Touch <Testing>.
3. Touch <Custom Sensory Integration>. The new protocol is listed (see Figure 7.16).

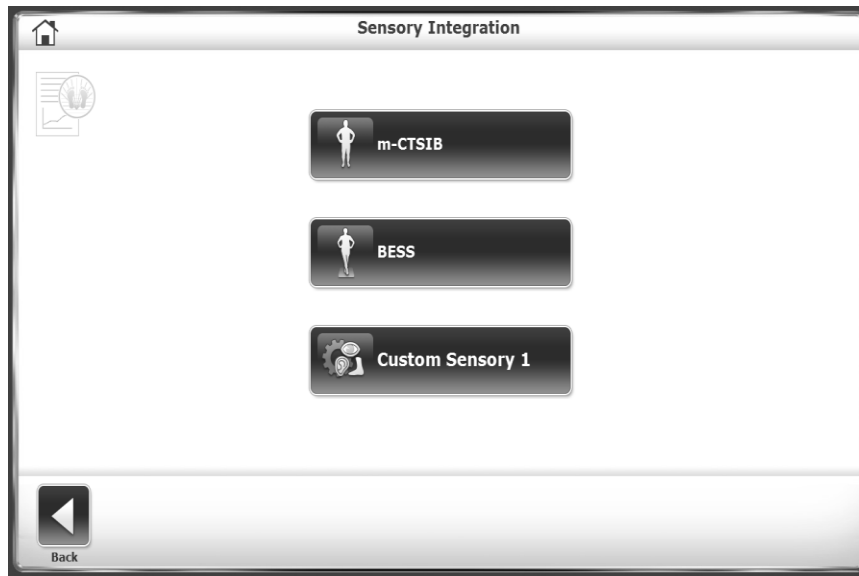















Figure 7.16. Sensory Integration Test Menu with Custom Test.

Patient Management

Select Patient Screen:

	Add Patient	Used to create a profile for a new patient.
	Delete	Used to delete records for a specific patient.
	Delete Range	Used to delete a selected range of records for a specific patient.
	Edit	Used to change the profile information for a specific patient.
	Export Multiple	Used to filter the files to export to a flash drive for a patient.
	Import	Used to import a patient file from a flash drive.

Patient Management – Test Results:

	Delete	Used to delete test results for a specific patient.
	Edit	Used to change the test results for a specific patient.
	Export CSV	Used to export a patient's test information to a flash drive.
	New Test	Used to return to the Test Menu to start a new testing session.
	New Training	Used to return to the Training Menu to start a new training session.
	Repeat	Used to repeat the selected test.
	View	Used to view the selected report.

1. Touch <Utilities> on the Main screen.
2. Touch <Patient Management>.
3. At the Access ID Code screen, enter the ID code 159 or the site's code, and touch <OK>. The Patient Management screen is displayed (see Figure 7.17).



Figure 7.17. Patient Management Screen.

- To create a profile for a new patient, touch <Add Patient>.
- To change information in an existing patient's profile, touch the patient's name to highlight the row and then touch <Edit>.
- To view a patient's test results, touch the patient's name and touch <Next>. The Patient Management - Test Results screen is displayed, as illustrated in Figure 7.18. Touch a test and then touch <Edit>. The results for that specific test are displayed.

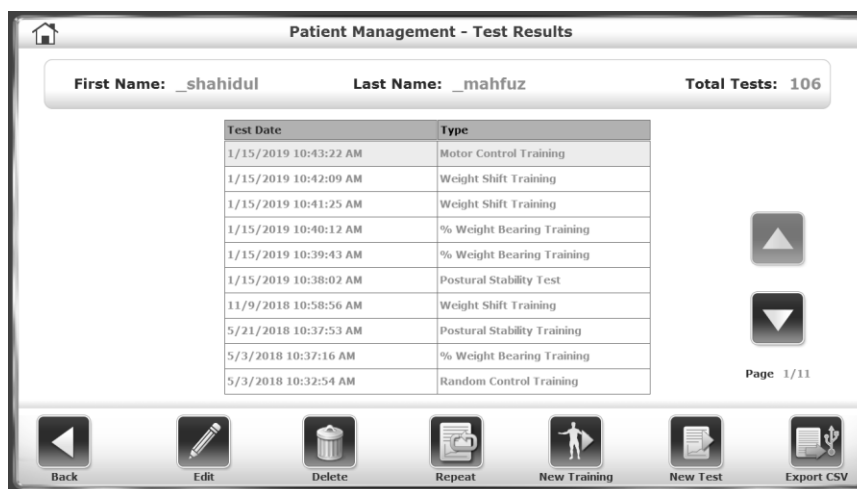

Figure 7.18. Selecting a Patient's Test Results.

Deleting Patient Files

All test results for a patient file or for multiple patients can be deleted, and patient data can be imported or exported.

Deleting a Single Patient File:

1. On the Select a Patient screen, touch the name to highlight the patient file.
2. Touch <Delete>.
3. Touch <OK> to confirm.

All test results for that patient are deleted.

Deleting a Range of Patient Files:

A specific type of test can be deleted (i.e., all Fall Risk Tests).

1. Touch <Delete Range>.
2. Select the range of patient records to delete: From a specific date, Prior To a specific date, between two dates (From/To). Enter the date.
3. Touch <OK> to confirm.
4. The selected files are deleted, and the system returns to the Patient Management screen.

Exporting Patient Data

Use Export Patient Data to copy a stored test to a file in the Biodex file format (.bio) or a CSV file format. A program such as Microsoft Excel can be used to open and edit the CSV file. For more information using CSV files, contact supportservices@biodex.com.

- Exporting and importing require a USB flash drive. Insert a flash drive into one of the USB ports on the display.

Exporting a Specific Patient File:

1. At the Patient Management screen, touch the patient's name and touch <Next>.
2. At the Patient Management – Test Results screen, touch <Export CSV>. The file is saved to a new folder named BioCsv on the USB flash drive.

Exporting a Set of Files:

1. At the Patient Management screen, touch <Export Multiple>.



Figure 7.19. Export Multiple Patient Files.

2. On the Multiple Data Export screen (see Figure 7.19), filter the files to export:
 - Set the Type: whole patient records or specify a test type.
 - Set the Time Frame: From a specific date, Prior To a specific date, between two dates (From/To). Enter the date.
3. Select the format to export: CSV or the Biodex proprietary format, biodata.
4. Touch <Export USB> to copy the filtered data to the folder named BioCsv or BioData.

To Export a Multi-Record Data:

Use the Time Frame option of All to export every patient test results for specific test type into a single CSV file. See Figure 7.20 for an example of this file in Microsoft Excel.

A	B	C	D	E	F	G	H	I	J	K	L	M	N	O	P	Q	R	S	T	U	V	W	X	Y	Z	AA	AB	AC	AD	AE					
1	Name	TestType	TestDate	Time	Patients	TestType	Number	CursorOn	Tracing	ToneIn	Record	FootAng	FootAng	HeelPos	HeelPos	RestCour	GCodeRe	GCodeCa	GCodeSt	GCodeAn	Impairm	ImpairCo	Availab	CPTCode	Commen	ICCCode	Diagnosi	Age	Height	Weight	UnitAddr	Devic			
2	Nasreen Nahar	CTSIB	1/17/2017	10:27	2	10	1	TRUE	TRUE	TRUE	FALSE	10	10 D6	D16	3	0	0	0	0	0	26	FALSE	TRUE	NONE					42 5' 5"	0	Balaa				
3	Shahidul Mahu	CTSIB	1/17/2017	15:53	1	30	1	FALSE	FALSE	TRUE	FALSE	10	10 D6	D16	10	1	0	0	0	0	0	0	FALSE	TRUE	NONE					41 5' 8"	0	Balaa			
4	Nasreen Nahar	CTSIB	1/18/2017	9:20	2	10	1	TRUE	TRUE	TRUE	FALSE	10	10 D6	D16	3	0	0	0	0	0	0	0	FALSE	TRUE	NONE					42 5' 3"	0	Balaa			
5	Nasreen Nahar	CTSIB	1/18/2017	9:21	2	10	1	TRUE	TRUE	TRUE	FALSE	10	10 D6	D16	3	0	0	0	0	0	0	0	FALSE	TRUE	NONE					42 5' 3"	0	Balaa			
6	Nasreen Nahar	CTSIB	1/18/2017	9:22	2	10	1	TRUE	TRUE	TRUE	FALSE	10	10 D6	D16	3	0	0	0	0	0	0	0	FALSE	TRUE	NONE					42 5' 3"	0	Balaa			
7	Nasreen Nahar	CTSIB	1/18/2017	9:25	2	10	1	TRUE	TRUE	TRUE	FALSE	10	10 D6	D16	3	0	0	0	0	0	0	0	FALSE	TRUE	NONE					42 5' 3"	0	Balaa			
8	Nasreen Nahar	CTSIB	1/18/2017	9:26	2	10	1	TRUE	TRUE	TRUE	FALSE	10	10 D6	D16	3	0	0	0	0	0	0	0	FALSE	TRUE	NONE					42 5' 3"	0	Balaa			
9	Nasreen Nahar	CTSIB	1/18/2017	9:27	2	10	1	TRUE	TRUE	TRUE	FALSE	10	10 D6	D16	3	0	0	0	0	0	0	0	FALSE	TRUE	NONE					42 5' 3"	0	Balaa			
10	Nasreen Nahar	CTSIB	1/18/2017	9:28	2	10	1	TRUE	TRUE	TRUE	FALSE	10	10 D6	D16	3	0	0	0	0	0	0	17	FALSE	TRUE	NONE					42 5' 3"	0	Balaa			
11	Nasreen Nahar	CTSIB	1/18/2017	9:30	2	10	1	TRUE	TRUE	TRUE	FALSE	10	10 D6	D16	3	0	0	0	0	0	0	0	FALSE	TRUE	NONE					42 5' 3"	0	Balaa			
12	Metric Patrick	CTSIB	1/17/2017	10:31	4	10	1	TRUE	TRUE	TRUE	FALSE	10	10 D6	D16	3	0	0	0	0	0	43	FALSE	TRUE	NONE	Actual test					98 5' 11"	134	Balaa			
13	Metric Patrick	CTSIB	1/17/2017	10:34	4	10	1	TRUE	TRUE	TRUE	FALSE	10	10 D6	D16	3	0	0	0	0	0	0	0	FALSE	TRUE	97002	Repeat of actual test.					98 5' 11"	134	Balaa		
14	Metric Patrick	CTSIB	1/17/2017	10:37	4	10	1	TRUE	TRUE	TRUE	FALSE	10	10 D6	D16	3	0	0	0	0	0	4	FALSE	TRUE	97002	going back to actual test					98 5' 11"	134	Balaa			
15	Y O	CTSIB	1/4/2017	14:01	5	30	1	FALSE	FALSE	TRUE	FALSE	10	10 D6	D16	10	0	0	0	0	0	0	0	FALSE	TRUE	97001					56 5' 5"	0	BioSh			
16		CTSIB	1/4/2017	10:03	6	10	1	FALSE	TRUE	TRUE	FALSE	10	10 D6	D16	10	0	0	0	0	0	66	FALSE	TRUE	NONE		Tt	yakampu					56 5' 2"	0	BioSh	

Figure 7.20. Multiple Patients Data in CSV File.

Importing Patient Data

Patient test files can be imported from the Biodex proprietary file format into a patient record.

1. Insert the flash drive with the file to import into one of the USB ports on the display.
2. On the Patient Management - Select a Patient screen, touch <Import>.
3. On the Patient Data File Import - USB Drive screen, touch the file.
4. Touch <Import Selected Data> (see Figure 7.21).

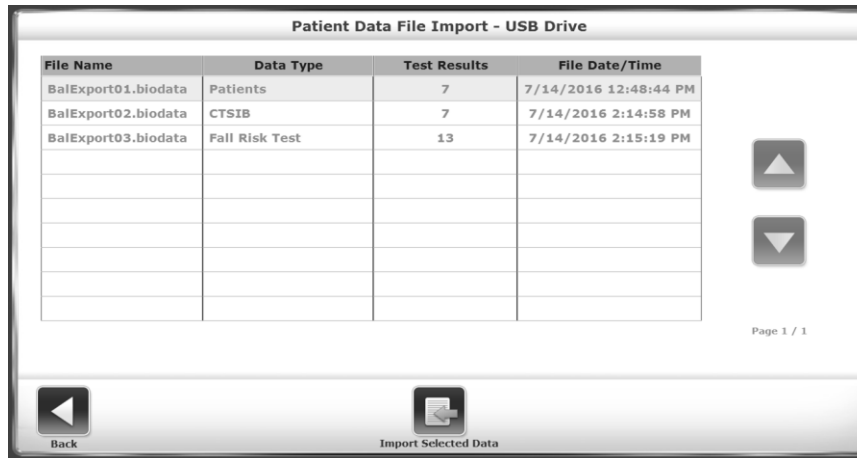

Figure 7.21. Import Patient Data Screen.

5. Depending on how the files were exported, options such as importing whole patient files or importing specific types of tests may be available.

Editing Stored Results

1. Codes and comments for a patient's test results can be selected.
2. Touch the patient's name to highlight the row, and then touch <Edit>.
3. From the Patient Management - Test Results screen, touch a test and then touch <Edit>. The system displays the Stored Test Results screen for the patient.
4. Make changes to the codes or comments and touch <Save>. The stored test results are updated.

8. VibroTactile™ System

Vibrotactile feedback or “cueing” incorporates a position-triggered, localized vibrating sensation on a belt worn by the patient. When patients close their eyes during a balance training session, the VibroTactile System provides biofeedback in the form of a “buzz” or vibration-cued signal. Vibrotactile cueing can be used as an indicator of positive reinforcement to affirm positional control. It can also indicate negative outcomes in instances where positional control is not achieved.

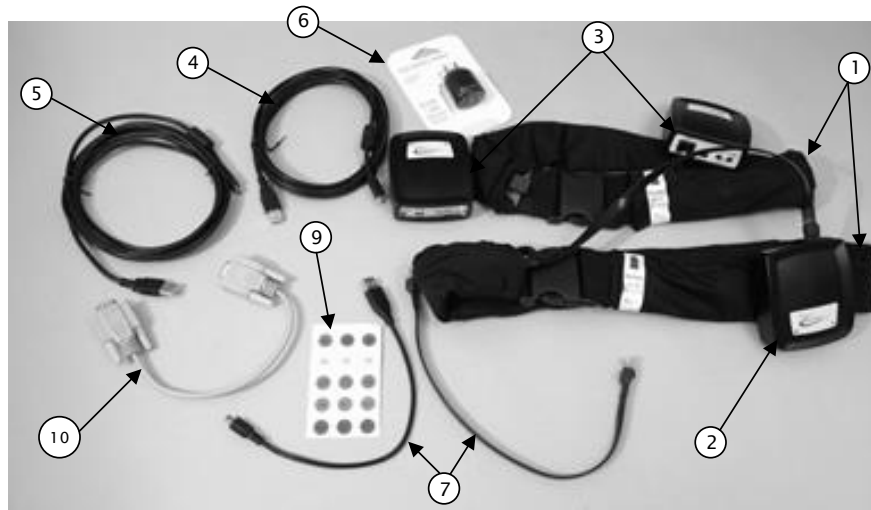

Figure.8.1.

Vibrotactile Kit, which includes:

- | | |
|---------------------------------------|---|
| 1. Two Belts (71-91 cm and 91-122 cm) | 6. AC/USB Charger |
| 2. Link Box | 7. Two RJ Connector Cables |
| 3. Two Tactile Belt Receivers | 8. Two Pieces of Hook/Loop Fastener (not shown) |
| 4. Short USB to micro USB Cable | 9. A Set of Labels |
| 5. Long USB to micro USB Cable | 10. Serial Cable (not used with Win 7 displays) |

Getting Started

Vibrotactile feedback must first be enabled on the Balance System SD Configuration screen as illustrated below in Figure 1.2:

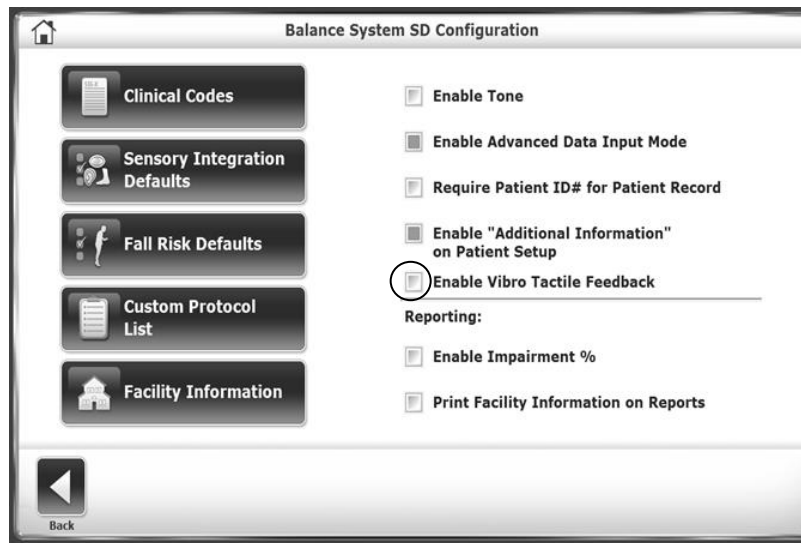

Figure 8.2. Enable VibroTactile Feedback Option on the Balance System SD Configuration Screen.

Attach the Link Box

The link box provides a wireless link between the tactile belt on the patient's waist and the biofeedback displayed on the screen. To install the link box, peel off the protective coverings on both parts of the fastener strip and position it on back of the display as illustrated in Figure 1.3.

Connect to the Display

The link box will communicate with the display using the short USB to Micro USB cable. Once connected, a blue light will come on indicating the link box is powered.



Figure 8.3. *Installing the LinkBox to the Back of the Display.*

Connect the tactile belt receiver boxes to the belts. The tactile belt receiver boxes for each are identical and can be interchanged if needed. Use the RJ Connector cable (see Figure 1.4) to connect the tactile belt receiver box to the connector on the tactile belt.



Figure 8.4. *Connecting the Tactile Receiver Box to the Belt.*

Clip the tactile belt receiver box to the belt fabric (see Figure 1.4).

Select the belt that best fits the patient. Place the belt around the patient's waist, arranging it with the red arrow pointing up and aligning with the patient's navel (see Figure 1.5).



Figure 8.5. *Align the Red Arrow on the Tactile Belt with the Patient's Navel.*

Touch the <LINK> button to wirelessly connect with the link box. <RESET> can be used to re-establish communication with link box should the connection be lost.

The link box is powered by the USB connection to the balance device's display. The tactile belt receiver boxes have rechargeable batteries. The batteries should provide more than enough service for a full day of clinical usage.

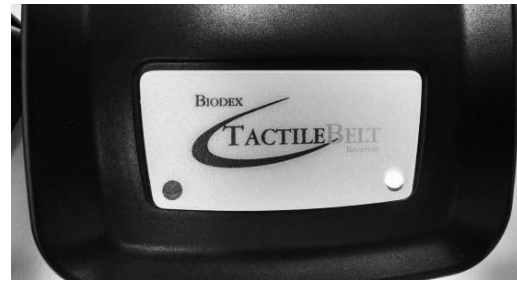

Figure 8.6. *Tactile Belt Receiver Box LED Indicators.*

There are two LED indicator lights on the tactile belt receiver boxes. The light on the left is for the battery status. The light on the right is for USB power.

Table 8.1. *Receiver Box Status.*

Indicator/Status	Color	Status
Battery Indicator	Solid Green	Battery charged half capacity or greater; trickle or not charging.
	Solid Orange	Battery charge less than half, but not critical.
	Solid Red	Battery charge is critically low; not charging.
	Slow Blink Green	Battery charged half capacity or greater; actively charging.
	Slow Blink Orange	Battery charge less than half, but not critical; actively charging.
	Slow Blink Red	Temperature out of range (0-40C, 32-104F).
	Fast Blink Orange	Initializing (one second only).
USB Power Status	Solid Blue	USB port powered.
	Dark	USB port not powered.

Indicator	Color	Status
LED on left	Solid Blue	Receiver Board is/was connected.
	Slow Blink Blue	Building wireless network (searching).
LED on right	Solid Blue	Active communications to application software.
	Dark	No communications to application software.

Table 8.2. LinkBox Indicator.

NOTE: When connecting a tactile belt receiver box, the connection status light can alternate from green to red, but the screen does not display a channel selection. If the belt has been idle for some time, it is “sleeping” and will not immediately connect. By touching the < RESET> button, the belt receiver “wakes up” and connects correctly.

There are two icons on the upper right corner of the display that indicate tactile belt/link box communication and tactile belt receiver box battery status; the first for wireless reception and the second for battery.



Figure 8.7 On-screen Indicator Illustrating Wireless Connection and Battery Life.

Charging the tactile belt receivers

There are two ways to charge the tactile belt receiver boxes:

1. Wall outlet charger (fastest charge).
2. USB connection to display.



Figure 8.8. Tactile Belt Receiver Boxes can be Charged with a Connection to a Wall Outlet or to the Display on the Device.

The long USB to Micro USB cable is long enough to use on the Vibro Tactile System while a tactile belt receiver box is charging (e.g., the battery is dead). The box can be plugged into the wall charger or into the display’s USB port while it is in use.

The vibrotactile component will not be activated until it is enabled on the Balance System SD Configuration screen (see Figure 1.2). When enabled during a training session, the tractors will vibrate as explained in the following table:

Training	Display	Description
Postural Stability		<p>The tactile belt tractors will vibrate:</p> <ol style="list-style-type: none"> 1. When the target is hit. Location of target will determine what tactor vibrates (e.g., a target at “2:00” on the screen will activate a tactor on the patient’s right hip). 2. When the therapist touches a concentric circle, it will become a “boundary” for the patient to stay within. As the patient moves the cursor over the screen, the tactor corresponding with boundary crossing will vibrate.
Weight Shift		<p>Tactors will vibrate when either of the two vertical blue target lines is hit.</p>





Training	Display	Description
Motor Control		<p>The factors corresponding with the on-screen targets will vibrate when the patient moves the cursor accordingly.</p>
Percent Weight Bearing		<p>Tactors corresponding with patient movement on direction planes will vibrate when the boundary is exceeded (on-screen graphic will display a blue color) and turn off when the patient stays within the boundary (graphic will be bright green.)</p>
Random Control		<p>As the patient moves to maintain the cursor within the randomly, roaming circle, tactors will vibrate if the cursor falls outside of circle. The vibration will stop when the patient is able to move the cursor back inside the circle.</p>
Maze Control		<p>The objective is for a patient to move the cursor through the maze hitting targets. If the maze walls (boundaries) are hit, tactors will vibrate until the patient brings the cursor back onto the maze path.</p>

Table 8.3. Balance Training Exercises with Eyes-Open or Eyes-Closed.

When vibrotactile feedback is being employed during a training session, it will be denoted at the top of the training report page:

Maze Control Training

PATIENT INFORMATION

Patient Name :
Patient ID : 8
Age : 57
Weight (kg) : 68
Height (cm) : 187
Gender : Male

SESSION INFORMATION

Date/ Time : 11.12.2017 10:28:09
Level : Easy
Parameters Modified : NO
Device / VT Belt : BioSway **ON**
CPT Code / ICD Code : YY,U

TRAINING RESULTS

Time: 00:03

Score: 0%

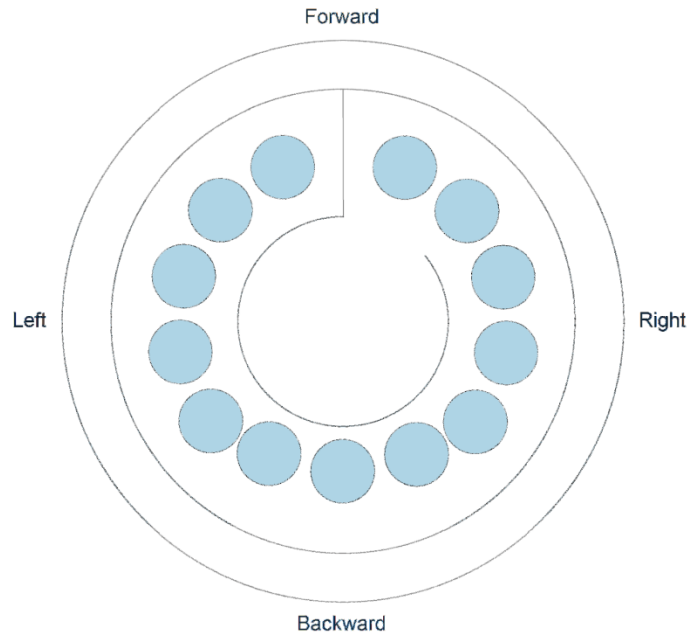

COMMENTS

CLINICIAN

Configuring Equipment in Facilities with One VibroTactile System

Each VibroTactile System comes with one link box and two tactile belt receiver boxes. The link box will be labeled with a sticker denoting A0, and the two tactile belt receiver boxes will be labeled A1 and A2.



A0

A1

A2

Figure 8.9. VibroTactile System Equipment Labeling.

On the screen displayed below, a line through the wireless connection/battery symbol denotes that no tactile belt is communicating with the link box. Touch the wireless/battery symbol once to configure tactile belt A1 or A2. In this example A1 is configured.



Figure 8.10. The Wireless Connection Battery Symbol is in the Upper Left Corner.

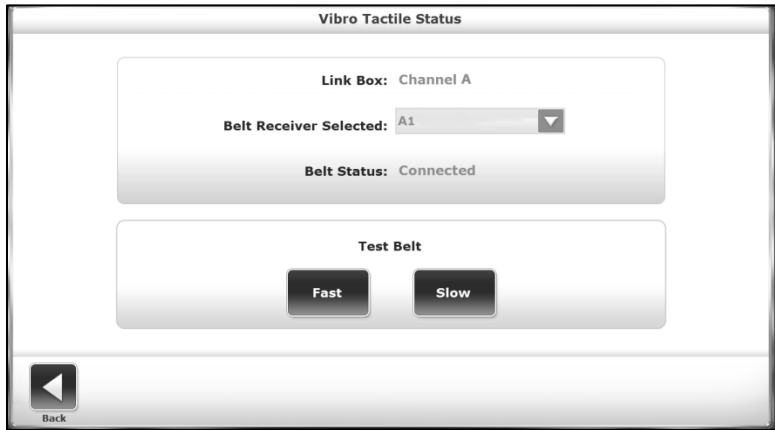

Figure 8.11. Use Drop-Down Menu to Select Tactile Belt Receiver Box.

Check the label to ensure that tactile belt receiver box A1 is being used, and touch <LINK> on that box. The link box should detect and connect with the A1 tactile belt receiver box.



Figure 8.12. Touch LINK to Wireless Connect the Tactile Belt Receiver Box.

Once the tactile belt box has been detected, perform a quick test. In a test, each tactor along the belt will vibrate. In addition to testing the tactors, this allows for the user to experience what the vibrotactile sensation is like.

For a tactor test, select <Fast> or <Slow>. In the Fast test, each tactor will vibrate for a ½ second. In the Slow test, tactors will vibrate for 1 second.

When finished, a screen will display stating that test is complete. There is no error message if a tactor did not vibrate. If a tactor is not vibrating during this test, something is not working correctly. Try performing the configuration steps again. If there is still a problem, contact Biodex customer service.

Note: Even if the link box and tactile belt receiver boxes do not need to be configured, a tactor test can be performed by touching the wireless/battery symbol on the main testing/training screen (Fig 1.10).

Touch <Back> to return to the main testing/training screen. Note that the wireless/battery symbol displays wireless connectivity, battery life, and the specific tactile belt box with which the link box is communicating.

Configuring Equipment in Facilities with Multiple VibroTactile Systems

If more than one VibroTactile System is purchased, some steps are required to ensure that the various link boxes and tactile belt boxes do not interfere with each other. Please contact Biodex Customer Support for assistance.

Patients with Pacemakers

At the time of writing, there is no information regarding use of the VibroTactile System with patients having pacemakers. Although the VibroTactile System uses considerably less power than the lowest power cellphone, it is best that pacemaker patients consult with a physician prior to using the device.

9. Maintenance

The Balance System SD requires only basic maintenance, performed as needed.

System Maintenance

Use the System Maintenance main menu get access to the following actions:

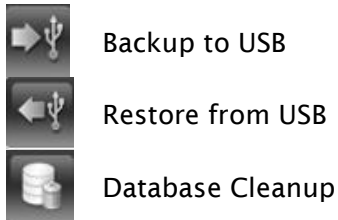

Backing Up Data to USB

The Backup operation makes a backup of the entire system, not only the database. All system selections and settings are backed up, including the facility name. Backup data is protected by password, which is the site Access ID code or the default code, 159

1. Insert a flash drive into one of the USB ports on the display.
2. Touch <Backup to USB>.
3. The system displays the message “System Backup Successful.” Touch <OK>.
4. Remove the flash drive. When the drive is viewed, the backup is in the BioBackup folder.

Restoring Data from USB

The Restore operation overwrites all settings, selections, and patient database. The system can only restore the data from backed up data on the flash drive.

1. Insert the flash drive with the backup file into one of the USB ports on the display.
2. Touch <Restore from USB>. A list of files is displayed. The most recent file is in the bottom row (see Figure 9.1).
3. Select the file to restore and touch <OK>. The time to restore depends on the size of the backup file.
4. When the system displays “Database Restore Complete,” touch <OK> to restart the Balance System SD software.

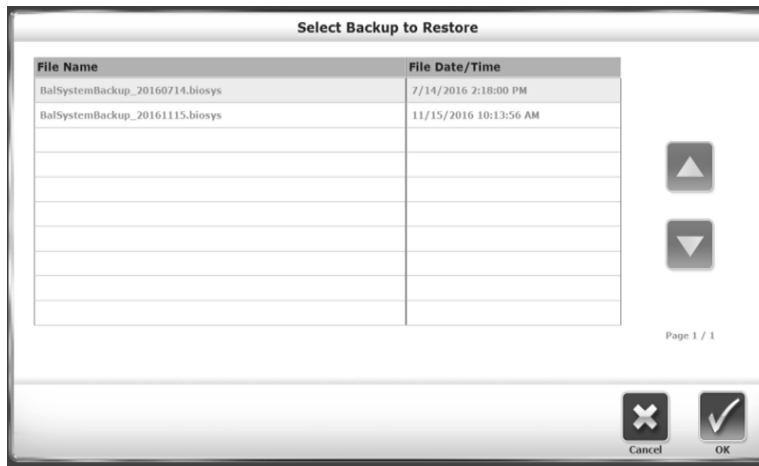

Figure 9.1. Select Backup to Restore Screen.

Compressing the Database

Database Cleanup compresses the system’s file size. Perform this operation according to the site’s policy.

Updating System Software

1. Download the latest software from www.biodex.com to a flash drive, in the root directory of the drive.
2. Go to the Home screen.
3. Insert the flash drive into one of the USB ports on the display.
4. The Software Update screen, illustrated in Figure 9.2, is displayed. Follow the directions to complete the update.



Figure 9.2. Software Update Screen.

Cleaning the Balance System

It is a good practice to wipe the support handles with disinfectant or cleaner after each use.

1. Disconnect the Balance System from the power supply.

-
2. Use a damp cloth to wipe all surfaces **except for the display**. For stains or scuff marks, use mild soap and water.
 3. Inspect all locking and adjustment mechanisms for signs of wear or damage.

Lubricating the System

We recommend applying a light grease to the treads of the FreeSway handles (if applicable) as needed.

The following internal parts use white lithium grease for lubrication:

- Spring assemblies
- Push plates (8)
- Acme threaded rods

To check these parts for adequate lubrication, remove the cover on the platform.

1. Remove the four screws holding the cover.
2. Remove the cover.
3. Before adding more lubricant, redistribute the existing lubricant and then run the system.



WARNING: When the Balance System is turned on without a cover, use extreme caution when observing or working on the system.

1. Spread the lubricant.
2. Turn on the system.

If the parts need more grease, use white lithium grease.

For questions or assistance, contact the Biodex Customer Service Department.

Maintaining the Printer

Follow the instructions in the printer manual.

If replacement ink cartridges cannot be found, contact either Biodex Support or a Biodex distributor.

Disposal

An appropriate waste disposal company is to be contacted (i.e., the local collection point for waste separation). Properly dispose of the device at the end of its service life:

- The device packaging is disposed of through resource recycling.
- The metal parts of the machine go to scrap metal disposal.
- Plastic parts are disposed of as hazardous waste.



The disposal of equipment must be in accordance with the respective national regulations.

Wear parts are considered hazardous waste! After being replaced, wear parts must be disposed of according to country-specific waste laws.

10. Specifications and Certifications

Dimensions:

Base: 28.5" w x 37" depth x 8.5" h (71 x 94 x 21.5 cm)

Platform: 21.5" diameter (55 cm)

Product Weight: 235 lb (106.5 kg)

All-In-One Flat Panel Display: 15.6" Color Touchscreen, Windows Operating System, Ethernet, USB, Video/Audio Out, Built-In Speakers and Color Printer. USB connectivity for data transfer and software upgrades.

Display Height: Adjustable from 55" to 68.5" h (139.7 to 174 cm) from center of display to floor, and 46" to 60" (117 152 cm) from center of display to platform.

Stability Levels: 12 dynamic levels, plus locked for static measurements

Platform Tilt: 20° from horizontal in all directions

Support Handles: Adjustable from 26" to 36" above platform (66 to 91 cm). Handles can be removed from the system when not in use or interchanged with the optional FreeSway Handles.

User Weight Capacity: Maximum: 400 lb (181 kg) **Minimum:** 60 lb (27 kg)

Printer: HP DeskJet

Printer Stand: 24" x 24" (61 x 61 cm)

Power: 115 VAC, 50/60 Hz, 15 amp line or 230 VAC, 50/60 Hz, 15 amp line

Power Rating: 520 watts

Certification: SGS Listed to ANSI/AAMI ES60601-1:2005+A1:2012+C1:2009+A2:2010 and CAN/CSA C22.2 No.:60601-1:2014.

CE conformity to IEC 60601-1:2012 reprint, EMC compliance to IEC 60601-1-2:2014.

Step Stool

Dimensions: 19.75" w x 13.5" depth x 4.5" h (50 x 34 x 11 cm)

Total Shipping Weight: 15 lb (7 kg)

VibroTactile

Belt Dimensions:

Small/Medium: 28"-36" (71-91 cm)

Large/Extra Large: 36"-48" (91-122 cm)

LinkBox Transmitter Voltage: 5v DC

Current: 50 mA

Auxiliary Ports: RS-232, USB

Tactile Belt Receiver Box Voltage: 5v DC

Current: 260 mA (when charging)

Auxiliary Ports: USB (wired); LR-WPAN (wireless)

US Patent for FreeSway Handles

US 9,415,287 B2



BIODEX

Biodex Medical Systems, Inc.

20 Ramsey Road, Shirley, New York, 11967-4704, Tel: 800-224-6339 (Int'l 631-924-9000), Fax: 631-924-9241, Email: info@biodex.com, www.biodex.com

